



OWNER'S MANUAL

**⚠ Read this manual carefully  
before operating this vehicle.**

**TRACER  
700**

MOTORCYCLE

---

**MTT690 (TRACER 700)**

**MTT690-U (TRACER 700)**

B4T-F8199-E1

Safety information	1
Description	2
Instrument and control functions	3
For your safety – pre-operation checks	4
Operation and important riding points	5
Periodic maintenance and adjustment	6
Motorcycle care and storage	7
Specifications	8
Consumer information	9
Index	10

 **Read this manual carefully before operating this vehicle. This manual should stay with this vehicle if it is sold.**

## **For Europe**

Declaration of Conformity:

Hereby, YAMAHA MOTOR ELECTRONICS Co., Ltd declares that the radio equipment type, IMMOBILIZER, 5SL-00 is in compliance with Directive 2014/53/EU.

The full text of the EU declaration of conformity is available at the following internet address:

[https://global.yamaha-motor.com/eu\\_doc/](https://global.yamaha-motor.com/eu_doc/)

Frequency band: 134.2 kHz

The maximum radio frequency power: 49.0 [dB $\mu$ V/m]

Manufacturer:

YAMAHA MOTOR ELECTRONICS Co., Ltd

1450-6 Mori, Mori-machi, Shuchi-Gun, Shizuoka, 437-0292 Japan

Importer:

YAMAHA MOTOR EUROPE N.V.

Koolhovenlaan 101, 1119 NC Schiphol-Rijk, 1117 ZN, Schiphol, the Netherlands

Welcome to the Yamaha world of motorcycling!

As the owner of the MTT690/MTT690-U, you are benefiting from Yamaha's vast experience and newest technology regarding the design and manufacture of high-quality products, which have earned Yamaha a reputation for dependability.

Please take the time to read this manual thoroughly, so as to enjoy all advantages of your MTT690/MTT690-U. The Owner's Manual does not only instruct you in how to operate, inspect and maintain your motorcycle, but also in how to safeguard yourself and others from trouble and injury.

In addition, the many tips given in this manual will help keep your motorcycle in the best possible condition. If you have any further questions, do not hesitate to contact your Yamaha dealer.

The Yamaha team wishes you many safe and pleasant rides. So, remember to put safety first!

Yamaha continually seeks advancements in product design and quality. Therefore, while this manual contains the most current product information available at the time of printing, there may be minor discrepancies between your motorcycle and this manual. If there is any question concerning this manual, please consult a Yamaha dealer.



---

**Please read this manual carefully and completely before operating this motorcycle.**



---

# Important manual information

---

EAU10134

Particularly important information is distinguished in this manual by the following notations:

	<b>This is the safety alert symbol. It is used to alert you to potential personal injury hazards. Obey all safety messages that follow this symbol to avoid possible injury or death.</b>
 <b>WARNING</b>	<b>A WARNING indicates a hazardous situation which, if not avoided, could result in death or serious injury.</b>
<b>NOTICE</b>	<b>A NOTICE indicates special precautions that must be taken to avoid damage to the vehicle or other property.</b>
<b>TIP</b>	A TIP provides key information to make procedures easier or clearer.

\*Product and specifications are subject to change without notice.

EAUM1013

**MTT690/MTT690-U  
OWNER'S MANUAL  
©2020 by MBK INDUSTRIE  
1st edition, March 2020  
All rights reserved  
Any reprinting or unauthorized use  
without the written permission of  
MBK INDUSTRIE  
is expressly prohibited.  
Printed in France.**

# Table of contents

---

<b>Safety information</b> .....	1-1	Luggage strap holders .....	3-24	Replacing the air filter element and cleaning the check hose .....	6-15
<b>Description</b> .....	2-1	Auxiliary DC connector .....	3-24	Checking the throttle grip free play.....	6-15
Left view .....	2-1	Sidestand .....	3-25	Valve clearance.....	6-16
Right view.....	2-2	Ignition circuit cut-off system .....	3-25	Tires .....	6-16
Controls and instruments .....	2-3			Cast wheels .....	6-18
<b>Instrument and control functions</b> ...	3-1	<b>For your safety – pre-operation checks</b> .....	4-1	Adjusting the clutch lever free play.....	6-19
Immobilizer system.....	3-1	<b>Operation and important riding points</b> .....	5-1	Checking the brake lever free play.....	6-19
Main switch/steering lock.....	3-2	Engine break-in .....	5-1	Brake light switches .....	6-20
Indicator lights and warning lights.....	3-3	Starting the engine.....	5-2	Checking the front and rear brake pads .....	6-20
Multi-function meter unit .....	3-6	Shifting .....	5-3	Checking the brake fluid level .....	6-21
Handlebar switches.....	3-12	Tips for reducing fuel consumption .....	5-4	Changing the brake fluid .....	6-22
Clutch lever .....	3-13	Parking .....	5-4	Drive chain slack.....	6-23
Shift pedal .....	3-13			Cleaning and lubricating the drive chain.....	6-24
Brake lever.....	3-14	<b>Periodic maintenance and adjustment</b> .....	6-1	Checking and lubricating the cables.....	6-25
Brake pedal .....	3-14	Tool kit .....	6-2	Checking and lubricating the throttle grip and cable .....	6-25
ABS .....	3-14	Periodic maintenance charts .....	6-3	Checking and lubricating the brake and shift pedals.....	6-26
Fuel tank cap.....	3-15	Periodic maintenance chart for the emission control system.....	6-3	Checking and lubricating the brake and clutch levers.....	6-26
Fuel.....	3-16	General maintenance and lubrication chart.....	6-5	Checking and lubricating the sidestand.....	6-27
Fuel tank breather hose and overflow hose.....	3-18	Checking the spark plugs .....	6-9	Lubricating the rear suspension ...	6-27
Catalytic converter .....	3-18	Canister .....	6-10		
Seat .....	3-19	Engine oil and oil filter cartridge....	6-10		
Helmet holding cable.....	3-19	Why Yamalube .....	6-13		
Storage compartment .....	3-20	Coolant.....	6-13		
Windshield .....	3-20				
Adjusting the front fork.....	3-21				
Adjusting the shock absorber assembly.....	3-22				

# Table of contents

---

Lubricating the swingarm	
pivots .....	6-28
Checking the front fork.....	6-28
Checking the steering .....	6-29
Checking the wheel bearings .....	6-29
Battery .....	6-29
Replacing the fuses.....	6-31
Vehicle lights .....	6-32
Replacing the license plate light	
bulb .....	6-32
Supporting the motorcycle.....	6-33
Troubleshooting .....	6-33
Troubleshooting chart .....	6-35
<b>Motorcycle care and storage</b> .....	7-1
Matte color caution .....	7-1
Care.....	7-1
Storage.....	7-3
<b>Specifications</b> .....	8-1
<b>Consumer information</b> .....	9-1
Identification numbers.....	9-1
Diagnostic connector .....	9-2
Vehicle data recording .....	9-2
<b>Index</b> .....	10-1

## Be a Responsible Owner

As the vehicle's owner, you are responsible for the safe and proper operation of your motorcycle.

Motorcycles are single-track vehicles. Their safe use and operation are dependent upon the use of proper riding techniques as well as the expertise of the operator. Every operator should know the following requirements before riding this motorcycle.

He or she should:

- Obtain thorough instructions from a competent source on all aspects of motorcycle operation.
- Observe the warnings and maintenance requirements in this Owner's Manual.
- Obtain qualified training in safe and proper riding techniques.
- Obtain professional technical service as indicated in this Owner's Manual and/or when made necessary by mechanical conditions.

- Never operate a motorcycle without proper training or instruction. Take a training course. Beginners should receive training from a certified instructor. Contact an authorized motorcycle dealer to find out about the training courses nearest you.

## Safe Riding

Perform the pre-operation checks each time you use the vehicle to make sure it is in safe operating condition. Failure to inspect or maintain the vehicle properly increases the possibility of an accident or equipment damage. See page 4-1 for a list of pre-operation checks.

- This motorcycle is designed to carry the operator and a passenger.
- The failure of motorists to detect and recognize motorcycles in traffic is the predominating cause of automobile/motorcycle accidents. Many accidents have been caused by an automobile driver who did not see the motorcycle. Making yourself conspicuous ap-

pears to be very effective in reducing the chance of this type of accident.

### Therefore:

- Wear a brightly colored jacket.
- Use extra caution when you are approaching and passing through intersections, since intersections are the most likely places for motorcycle accidents to occur.
- Ride where other motorists can see you. Avoid riding in another motorist's blind spot.
- Never maintain a motorcycle without proper knowledge. Contact an authorized motorcycle dealer to inform you on basic motorcycle maintenance. Certain maintenance can only be carried out by certified staff.



- Many accidents involve inexperienced operators. In fact, many operators who have been involved in accidents do not even have a current motorcycle license.
  - Make sure that you are qualified and that you only lend your motorcycle to other qualified operators.
  - Know your skills and limits. Staying within your limits may help you to avoid an accident.
  - We recommend that you practice riding your motorcycle where there is no traffic until you have become thoroughly familiar with the motorcycle and all of its controls.
- Many accidents have been caused by error of the motorcycle operator. A typical error made by the operator is veering wide on a turn due to excessive speed or undercornering (insufficient lean angle for the speed).
  - Always obey the speed limit and never travel faster than warranted by road and traffic conditions.
- Always signal before turning or changing lanes. Make sure that other motorists can see you.
- The posture of the operator and passenger is important for proper control.
  - The operator should keep both hands on the handlebar and both feet on the operator footrests during operation to maintain control of the motorcycle.
  - The passenger should always hold onto the operator, the seat strap or grab bar, if equipped, with both hands and keep both feet on the passenger footrests. Never carry a passenger unless he or she can firmly place both feet on the passenger footrests.
- Never ride under the influence of alcohol or other drugs.
- This motorcycle is designed for on-road use only. It is not suitable for off-road use.

### **Protective Apparel**

The majority of fatalities from motorcycle accidents are the result of head injuries. The use of a safety helmet is the single most critical factor in the prevention or reduction of head injuries.

- Always wear an approved helmet.
- Wear a face shield or goggles. Wind in your unprotected eyes could contribute to an impairment of vision that could delay seeing a hazard.
- The use of a jacket, heavy boots, trousers, gloves, etc., is effective in preventing or reducing abrasions or lacerations.
- Never wear loose-fitting clothes, otherwise they could catch on the control levers, footrests, or wheels and cause injury or an accident.
- Always wear protective clothing that covers your legs, ankles, and feet. The engine or exhaust system become very hot during or after operation and can cause burns.
- A passenger should also observe the above precautions.

# Safety information

1

## Avoid Carbon Monoxide Poisoning

All engine exhaust contains carbon monoxide, a deadly gas. Breathing carbon monoxide can cause headaches, dizziness, drowsiness, nausea, confusion, and eventually death.

Carbon Monoxide is a colorless, odorless, tasteless gas which may be present even if you do not see or smell any engine exhaust. Deadly levels of carbon monoxide can collect rapidly and you can quickly be overcome and unable to save yourself. Also, deadly levels of carbon monoxide can linger for hours or days in enclosed or poorly ventilated areas. If you experience any symptoms of carbon monoxide poisoning, leave the area immediately, get fresh air, and SEEK MEDICAL TREATMENT.

- Do not run engine indoors. Even if you try to ventilate engine exhaust with fans or open windows and doors, carbon monoxide can rapidly reach dangerous levels.
- Do not run engine in poorly ventilated or partially enclosed areas such as barns, garages, or carports.

- Do not run engine outdoors where engine exhaust can be drawn into a building through openings such as windows and doors.

## Loading

Adding accessories or cargo to your motorcycle can adversely affect stability and handling if the weight distribution of the motorcycle is changed. To avoid the possibility of an accident, use extreme caution when adding cargo or accessories to your motorcycle. Use extra care when riding a motorcycle that has added cargo or accessories. Here, along with the information about accessories below, are some general guidelines to follow if loading cargo to your motorcycle:

The total weight of the operator, passenger, accessories and cargo must not exceed the maximum load limit.

**Operation of an overloaded vehicle could cause an accident.**

**Maximum load:**  
181 kg (399 lb)

When loading within this weight limit, keep the following in mind:

- Cargo and accessory weight should be kept as low and close to the motorcycle as possible. Securely pack your heaviest items as close to the center of the vehicle as possible and make sure to distribute the weight as evenly as possible on both sides of the motorcycle to minimize imbalance or instability.
- Shifting weights can create a sudden imbalance. Make sure that accessories and cargo are securely attached to the motorcycle before riding. Check accessory mounts and cargo restraints frequently.
- Properly adjust the suspension for your load (suspension-adjustable models only), and check the condition and pressure of your tires.
- Never attach any large or heavy items to the handlebar, front fork, or front fender. These items, including such cargo as sleeping bags, duffel bags, or

tents, can create unstable handling or a slow steering response.

- **This vehicle is not designed to pull a trailer or to be attached to a sidecar.**

### **Genuine Yamaha Accessories**

Choosing accessories for your vehicle is an important decision. Genuine Yamaha accessories, which are available only from a Yamaha dealer, have been designed, tested, and approved by Yamaha for use on your vehicle.

Many companies with no connection to Yamaha manufacture parts and accessories or offer other modifications for Yamaha vehicles. Yamaha is not in a position to test the products that these aftermarket companies produce. Therefore, Yamaha can neither endorse nor recommend the use of accessories not sold by Yamaha or modifications not specifically recommended by Yamaha, even if sold and installed by a Yamaha dealer.

### **Aftermarket Parts, Accessories, and Modifications**

While you may find aftermarket products similar in design and quality to genuine Yamaha accessories, recognize that some aftermarket accessories or modifications are not suitable because of potential safety hazards to you or others. Installing aftermarket products or having other modifications performed to your vehicle that change any of the vehicle's design or operation characteristics can put you and others at greater risk of serious injury or death. You are responsible for injuries related to changes in the vehicle.

Keep the following guidelines in mind, as well as those provided under "Loading" when mounting accessories.

- Never install accessories or carry cargo that would impair the performance of your motorcycle. Carefully inspect the accessory before using it to make sure that it does not in any way reduce ground clearance or cornering clearance, limit suspension travel,

steering travel or control operation, or obscure lights or reflectors.

- Accessories fitted to the handlebar or the front fork area can create instability due to improper weight distribution or aerodynamic changes. If accessories are added to the handlebar or front fork area, they must be as lightweight as possible and should be kept to a minimum.
- Bulky or large accessories may seriously affect the stability of the motorcycle due to aerodynamic effects. Wind may attempt to lift the motorcycle, or the motorcycle may become unstable in cross winds. These accessories may also cause instability when passing or being passed by large vehicles.
- Certain accessories can displace the operator from his or her normal riding position. This improper position limits the freedom of movement of the

## Safety information

---

1

operator and may limit control ability, therefore, such accessories are not recommended.

- Use caution when adding electrical accessories. If electrical accessories exceed the capacity of the motorcycle's electrical system, an electric failure could result, which could cause a dangerous loss of lights or engine power.

### **Aftermarket Tires and Rims**

The tires and rims that came with your motorcycle were designed to match the performance capabilities and to provide the best combination of handling, braking, and comfort. Other tires, rims, sizes, and combinations may not be appropriate. See page 6-16 for tire specifications and for information on servicing and replacing your tires.

### **Transporting the Motorcycle**

Be sure to observe following instructions before transporting the motorcycle in another vehicle.

- Remove all loose items from the motorcycle.
- Check that the fuel cock (if equipped) is in the off position and that there are no fuel leaks.
- Shift the transmission into gear (for models with a manual transmission).
- Secure the motorcycle with tie-downs or suitable straps that are attached to solid parts of the motorcycle, such as the frame or upper front fork triple clamp (and not, for example, to rubber-mounted handlebars or turn signals, or parts that could break). Choose the location for the straps carefully so the straps will not rub against painted surfaces during transport.
- The suspension should be compressed somewhat by the tie-downs, if possible, so that the motorcycle will not bounce excessively during transport.

## Left view

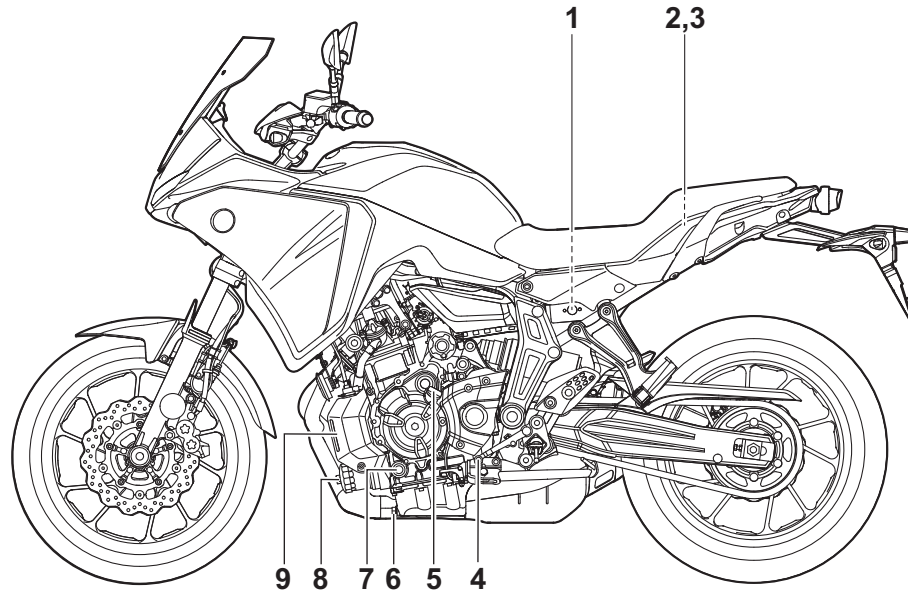

1. Seat lock (page 3-19)

2. Storage compartment (page 3-20)

3. Tool kit (page 6-2)

4. Shift pedal (page 3-13)

5. Engine oil filler cap (page 6-10)

6. Engine oil drain bolt (page 6-10)

7. Engine oil level check window (page 6-10)

8. Engine oil filter cartridge (page 6-10)

9. Coolant reservoir (page 6-13)

# Description

EAU10421

## Right view

2

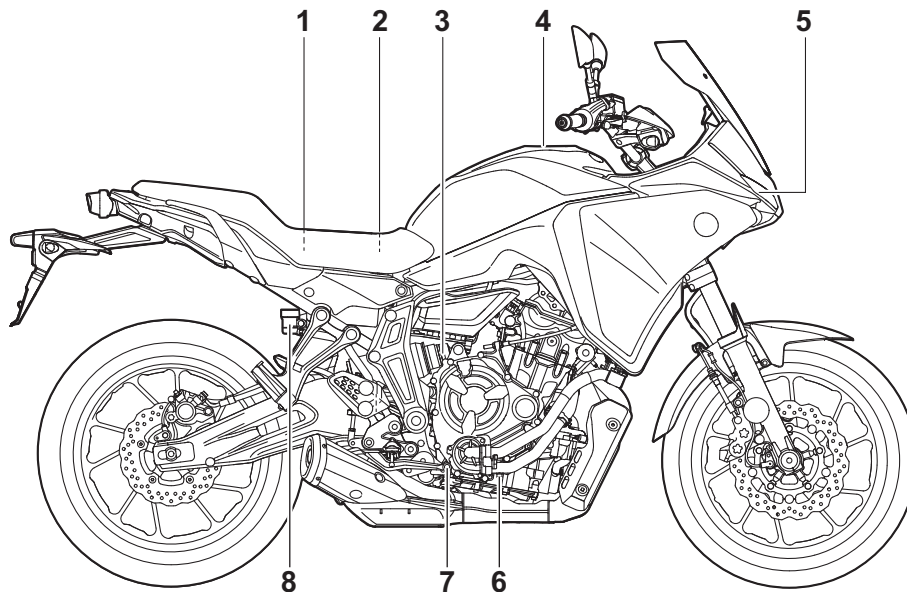

1. Fuses (page 6-31)
2. Battery (page 6-29)
3. Shock absorber assembly spring preload adjusting ring (page 3-22)
4. Fuel tank cap (page 3-15)
5. Headlight (page 6-32)
6. Coolant drain bolt (page 6-14)
7. Brake pedal (page 3-14)
8. Rear brake fluid reservoir (page 6-21)

## Controls and instruments

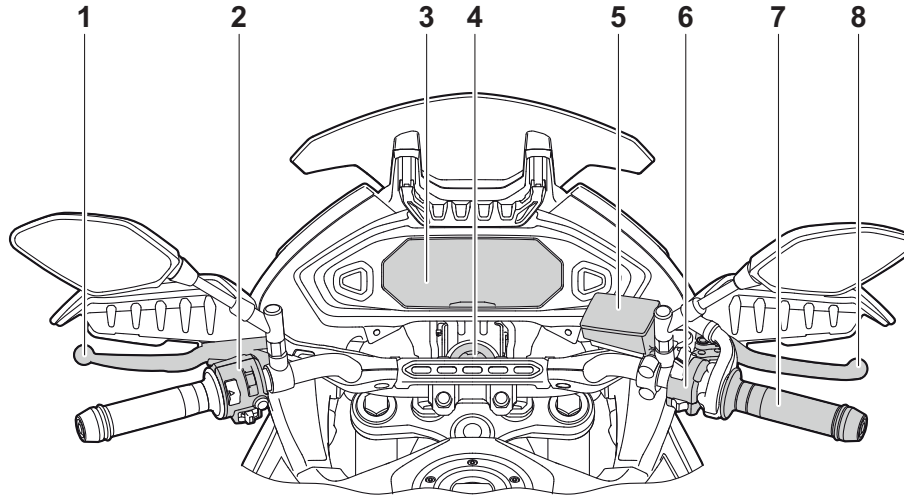
**2**

1. Clutch lever (page 3-13)
2. Left handlebar switches (page 3-12)
3. Multi-function meter unit (page 3-6)
4. Main switch/steering lock (page 3-2)
5. Front brake fluid reservoir (page 6-21)
6. Right handlebar switches (page 3-12)
7. Throttle grip (page 6-15)
8. Brake lever (page 3-14)

# Instrument and control functions

3

## Immobilizer system

EAU1097A

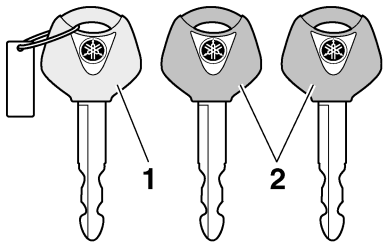

1. Code re-registering key (red bow)
2. Standard keys (black bow)

This vehicle is equipped with an immobilizer system to help prevent theft by re-registering codes in the standard keys. This system consists of the following:

- a code re-registering key
- two standard keys
- a transponder (in each key)
- an immobilizer unit (on the vehicle)
- an ECU (on the vehicle)
- a system indicator light (page 3-5)

### About the keys

The code re-registering key acts like a master key. It is used to register codes in each standard key. Store the code re-registering key in a safe place. Use a standard key for daily operation.

When key replacement or re-registering is necessary, bring the vehicle and the master key along with any remaining standard keys to a Yamaha dealer to have them re-registered.

### TIP

- Keep the standard keys as well as keys of other immobilizer systems away from the code re-registering key.
- Keep other immobilizer system keys away from the main switch as they may cause signal interference.

ECA11823

### NOTICE

**DO NOT LOSE THE CODE RE-REGISTERING KEY! CONTACT YOUR DEALER IMMEDIATELY IF IT IS LOST! If the code re-registering key is lost, the existing standard keys can still be used to start the vehicle.**

However, registering a new standard key is impossible. If all keys have been lost or damaged, the entire immobilizer system must be replaced. Therefore, handle the keys carefully.

- Do not submerge in water.
- Do not expose to high temperatures.
- Do not place near magnets.
- Do not place near items that transmit electrical signals.
- Do not handle roughly.
- Do not grind or alter.
- Do not disassemble.
- Do not put two keys of any immobilizer system on the same key ring.



## Main switch/steering lock

EAU10474

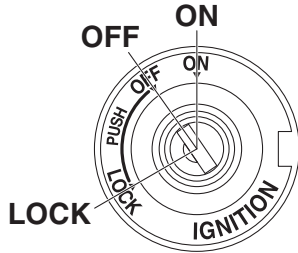

The main switch/steering lock controls the ignition and lighting systems, and is used to lock the steering. The various positions are described below.

### TIP

Be sure to use the standard key (black bow) for regular use of the vehicle. To minimize the risk of losing the code registering key (red bow), keep it in a safe place and only use it for code re-registering.

### ON

All electrical circuits are supplied with power and the vehicle lights are turned on. The engine can be started. The key cannot be removed.

### TIP

- To prevent battery discharge, do not leave the key in the on position without the engine running.
- The headlight comes on automatically when the engine is started.
- The headlight will stay on until the key is turned to “OFF”, even if the engine stalls.

### OFF

All electrical systems are off. The key can be removed.

### **⚠ WARNING**

**Never turn the key to “OFF” or “LOCK” while the vehicle is moving. Otherwise the electrical systems will be switched off, which may result in loss of control or an accident.**

### LOCK

The steering is locked and all electrical systems are off. The key can be removed.

### To lock the steering

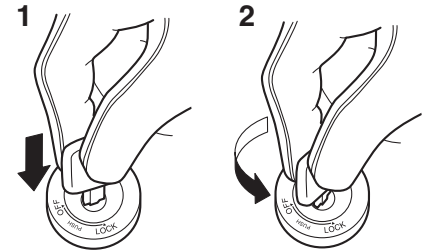

1. Push.
2. Turn.

1. Turn the handlebars all the way to the left.
2. With the key in the “OFF” position, push the key in and turn it to “LOCK”.
3. Remove the key.

# Instrument and control functions

**TIP** \_\_\_\_\_  
If the steering will not lock, try turning the handlebars back to the right slightly.

3

## To unlock the steering

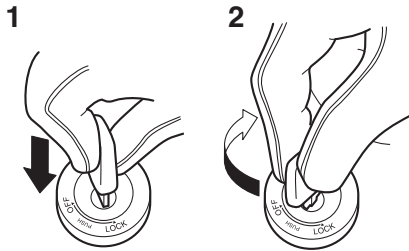







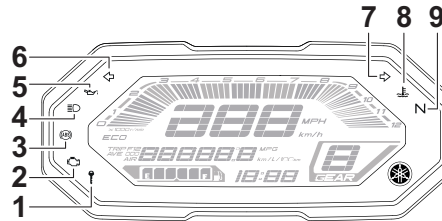

1. Push.
2. Turn.

Push the key in and turn it to “OFF”.

## Indicator lights and warning lights

EAU4939J



1. Immobilizer system indicator light “”
2. Malfunction indicator light “”
3. Anti-lock Brake System (ABS) warning light “”
4. High beam indicator light “”
5. Oil pressure warning light “”
6. Left turn signal indicator light “”
7. Right turn signal indicator light “”
8. Coolant temperature warning light “”
9. Neutral indicator light “**N**”

## Turn signal indicator lights “” and “”

EAU11032

Each indicator light will flash when its corresponding turn signal lights are flashing.

## Neutral indicator light “**N**”

EAU11061

This indicator light comes on when the transmission is in the neutral position.

## High beam indicator light “”

EAU11081

This indicator light comes on when the high beam of the headlight is switched on.

## Oil pressure warning light “”

EAU59963

This warning light comes on if the engine oil pressure is low.

**TIP** \_\_\_\_\_

When the vehicle is turned on, the light should come on, go off briefly, and then remain on until the engine is started. Otherwise, have a Yamaha dealer check the vehicle.

## **NOTICE** \_\_\_\_\_

ECA21211

**If the warning light comes on when the engine is running, stop the engine and check the oil level. If the oil level is low, add sufficient oil of the recommended type. If the warning**

light remains on after adding oil, stop the engine and have a Yamaha dealer check the vehicle.

## Coolant temperature warning light “”

EAU11449

This warning light comes on when the engine is overheating. If this occurs, stop the engine immediately and allow the engine to cool. (See page 6-36.) For vehicles with a radiator fan, the radiator fan(s) automatically switch on or off according to the coolant temperature.

### TIP

When the vehicle is turned on, the light will come on for a few seconds, and then go off. If the light does not come on, or if the light remains on, have a Yamaha dealer check the vehicle.

ECA10022

### NOTICE

**Do not continue to operate the engine if it is overheating.**

## Malfunction indicator light (MIL) “”

EAU88330

This light comes on or flashes if a problem is detected in the engine or other vehicle control system. If this occurs, have a Yamaha dealer check the on-board diagnostic system. The electrical circuit of the warning light can be checked by vehicle power on. The light should come on for a few seconds, and then go off. If the light does not come on initially when the vehicle power on, or if the light remains on, have a Yamaha dealer check the vehicle.

ECA26820

### NOTICE

**If the MIL starts flashing, reduce engine speed to prevent exhaust system damage.**

### TIP

The engine is sensitively controlled for the on-board diagnostic system to detect deterioration and malfunction of the emission control system. Due to this specification, the MIL may come on or flash for vehicle modifications, lack of maintenance, or excessive or

improper use of the motorcycle. To prevent this, observe these precautions.

- Do not attempt to modify the software of the engine control unit.
- Do not add any electrical accessories that interfere with engine control.
- Do not use aftermarket accessories or parts such as suspension, spark plugs, injectors, exhaust system, etc.
- Do not change drivetrain specifications (chain, sprockets, wheels, tires, etc.).
- Do not remove or alter the O2 sensor, air induction system, or exhaust parts (catalysts or EXUP, etc.).
- Maintain proper drive chain.
- Maintain correct tire pressure.
- Maintain proper brake pedal height to prevent rear brake from dragging.
- Do not operate the vehicle in an extreme manner. For example, repeated or excessive opening and

# Instrument and control functions

---

closing of the throttle, racing, burnouts, wheelies, extended half-clutch use, etc.

---

## 3 ABS warning light “”

EAU69895

This warning light comes on when the vehicle is first turned on, and goes off after starting riding. If the warning light comes on while riding, the anti-lock brake system may not work correctly.

EWA16043

### **WARNING**

**If the ABS warning light does not turn off after reaching 10 km/h (6 mi/h), or if the warning light comes on while riding:**

- **Use extra caution to avoid possible wheel lock during emergency braking.**
  - **Have a Yamaha dealer check the vehicle as soon as possible.**
- 

EAM3622

## Immobilizer system indicator light “”

When the vehicle is turned off and 30 seconds have passed, the indicator light will flash steadily to indicate the

immobilizer system is enabled. After 24 hours have passed, the indicator light will stop flashing, however the immobilizer system is still enabled.

### TIP

When the vehicle is turned on, the light will come on for a few seconds, and go off. Otherwise, have a Yamaha dealer check the vehicle.

---

### Troubleshooting

If a problem is detected in the immobilizer system, the light will flash in a pattern. If the immobilizer system indicator light flashes in the pattern, slowly 5 times then quickly 2 times, this could be caused by transponder interference. If this occurs, try the following.

1. Make sure there are no other immobilizer keys close to the main switch. Other immobilizer system keys may cause signal interference and prevent the engine from starting.
2. Use the code re-registering key to start the engine.

3. If the engine starts, turn it off, and try starting the engine with the standard keys.
4. If one or more of the standard keys do not start the engine, take the vehicle and all keys to a Yamaha dealer to have the standard keys re-registered.

## Multi-function meter unit

EAM4251

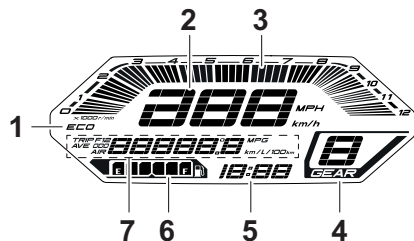

1. Eco indicator “ECO”
2. Speedometer
3. Tachometer
4. Transmission gear display
5. Clock
6. Fuel meter
7. Multi-function display

The multi-function meter unit is equipped with the following:

- speedometer
- tachometer
- fuel meter
- clock
- eco indicator
- transmission gear display
- multi-function display

EWA12423

### **⚠ WARNING**

**Be sure to stop the vehicle before making any setting changes to the multi-function meter unit. Changing settings while riding can distract the operator and increase the risk of an accident.**

The “TRIP/INFO” switch is located on the left side of the handlebar. This switch allows you to control or change the settings of the multi-function meter unit. To use the “TRIP” switch, move the “TRIP/INFO” switch in direction (a). To use the “INFO” switch, move the “TRIP/INFO” switch in direction (b).

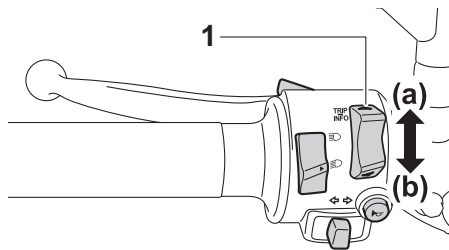

1. “TRIP/INFO” switch

### TIP

- To switch between kilometers and miles, set the multi-function display to the odometer, and then turn the key to “OFF”. Push and hold the “TRIP” switch and then turn the key to “ON”. Continue pushing the “TRIP” switch until display units change.
- The display units will return to factory settings in case of battery disconnection.

3

EWA12423

### **⚠ WARNING**

**Be sure to stop the vehicle before making any setting changes to the multi-function meter unit. Changing settings while riding can distract the operator and increase the risk of an accident.**

### Speedometer

The speedometer shows the vehicle’s traveling speed.

# Instrument and control functions

## Tachometer

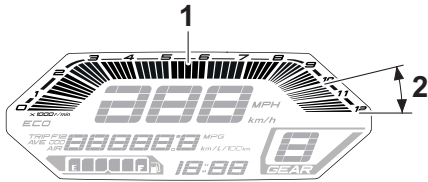

1. Tachometer
2. Tachometer red zone

The tachometer shows the engine speed.

ECA10032

### **NOTICE**

**Do not operate the engine in the tachometer red zone.**

**Red zone: 10000 r/min and above**

## Fuel meter

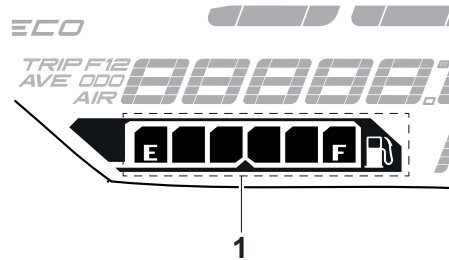

1. Fuel meter

The fuel meter indicates the amount of fuel in the fuel tank. The segments of the fuel meter disappear from “F” (full) towards “E” (empty) as the fuel level decreases. When the last segment of the fuel meter starts flashing, refuel as soon as possible.

### **TIP**

If a problem is detected in the electrical circuit, the fuel meter segments will flash repeatedly. If this occurs, have a Yamaha dealer check the vehicle.

## Eco indicator

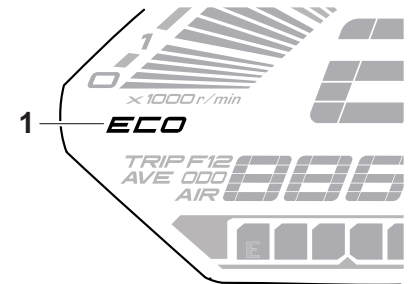

1. Eco indicator “ECO”

This indicator comes on when the vehicle is being operated in an environmentally friendly, fuel-efficient manner. The indicator goes off when the vehicle is stopped.

### **TIP**

Consider the following tips to reduce fuel consumption:

- Avoid high engine speeds during acceleration.
- Travel at a constant speed.
- Select the transmission gear that is appropriate for the vehicle speed.

## Transmission gear display



1. Transmission gear display

The transmission gear display shows the selected gear. The neutral position is indicated by “-”.

## Clock



1. Clock

The clock uses a 12-hour time system.

## To set the clock

1. Set the multi-function display to “ODO”
2. Push the “TRIP” switch until the hour digits start flashing.
3. Push the “TRIP” switch to set the hours.
4. Push the “INFO” switch and the minute digits will start flashing.
5. Push the “TRIP” switch to set the minutes.
6. Push the “INFO” switch to confirm settings and start the clock.

## TIP

When setting the hours and minutes, push the “TRIP” switch briefly to increase the increment value one by one, or push and hold the switch to increase the increment value continuously.

## Multi-function display

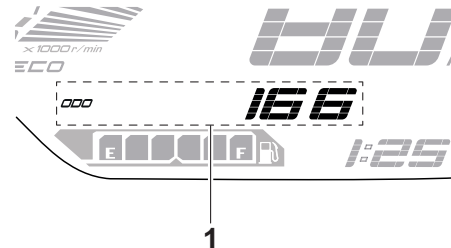

1. Multi-function display

The multi-function display can show:

- an odometer
- two tripmeters
- a fuel reserve tripmeter
- an instantaneous fuel consumption display
- an average fuel consumption display
- a coolant temperature display
- an air temperature display
- a brightness control mode

The odometer shows the total distance the vehicle has traveled. The standard tripmeters show the distance traveled since they were last reset. The fuel re-

# Instrument and control functions

serve tripmeter shows the distance traveled since the last segment of the fuel meter began flashing.

## TIP

- The odometer will lock at 999999 and cannot be reset.
- The tripmeter will reset to 0 and continue counting after 9999.9 is reached.

Push the “TRIP” switch briefly to switch the display in the following order:

ODO → TRIP 1 → TRIP 2 → TRIP F → km/L or L/100 km or MPG → AVE\_ \_ \_ km/L or AVE\_ \_ \_ L/100 km or AVE\_ \_ \_ MPG → \_ \_ °C → Air\_ \_ °C → ODO

## TIP

- Push the “INFO” switch briefly to switch the display in the reverse order.
- The display changes to fuel reserve tripmeter “TRIP F” when the last segment of the fuel meter starts flashing.

- To reset a tripmeter, select it by pushing the “TRIP” switch or the “INFO” switch, and while the digits are flashing, push the “INFO” switch until it is reset.
- If you do not reset the fuel reserve tripmeter manually, it will reset automatically and disappear from the display after refueling and traveling 5 km (3 mi).

## Fuel reserve tripmeter

When the fuel level becomes low, the last segment of the fuel meter will start flashing. The fuel reserve tripmeter “TRIP F” will automatically appear and start counting the distance traveled from that point. In this case, push the “TRIP” switch to switch the display in the following order:

TRIP F → km/L or L/100 km → AVE\_ \_ \_ km/L or AVE\_ \_ \_ L/100 km → \_ \_ °C → Air\_ \_ °C → ODO → TRIP 1 → TRIP 2 → TRIP F

For the UK:

TRIP F → MPG → AVE\_ \_ \_ MPG → \_ \_ °C → Air\_ \_ °C → ODO → TRIP 1 → TRIP 2 → TRIP F

## TIP

- Push the “INFO” switch to change the display in the reverse order.
- You can manually reset the fuel reserve tripmeter, or after refueling and traveling 5 km (3 mi) it will reset automatically and disappear from the display.

## Instantaneous fuel consumption

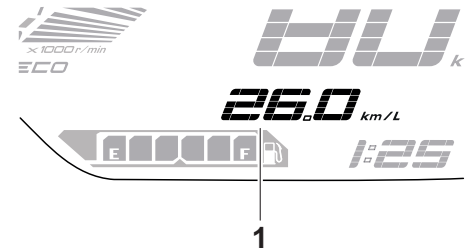

1. Instantaneous fuel consumption display

This function calculates the fuel consumption under current riding conditions.



The instantaneous fuel consumption display can be set to either “km/L”, “L/100 km” when using kilometers.

To switch the the fuel consumption units, push the “TRIP” switch until the measurement units change. When using miles, the fuel consumption unit is “MPG”.

- “km/L”: The distance that can be traveled on 1.0 L of fuel under the current riding conditions is shown.
- “L/100 km”: The amount of fuel necessary to travel 100 km under the current riding conditions is shown.
- “MPG”: The distance that can be traveled on 1.0 Imp.gal of fuel under the current riding conditions is shown.

To switch the instantaneous fuel consumption settings, push and hold “TRIP” switch until the display changes.

**TIP** \_\_\_\_\_  
If traveling at speeds under 20 km/h (12 mi/h), “\_ \_ . \_” is displayed.

## Average fuel consumption

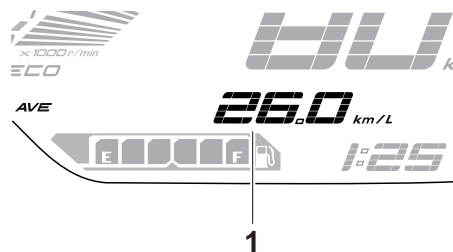

1. Average fuel consumption display

This display shows the average fuel consumption since it was last reset.

The average fuel consumption can be set to either “AVE\_ \_ . \_ km/L”, “AVE\_ \_ . \_ L/100 km” when using kilometers. To switch the fuel consumption units, when the display is steady, push the “TRIP” switch until the measurement units change. When using miles, the fuel consumption is “AVE\_ \_ . \_ MPG”.

- “AVE\_ \_ . \_ km/L”: The average distance that can be traveled on 1.0 L of fuel is shown.
- “AVE\_ \_ . \_ L/100 km”: The average amount of fuel necessary to travel 100 km is shown.

- “AVE\_ \_ . \_ MPG”: The average distance that can be traveled on 1.0 Imp.gal of fuel is shown.

To reset the average fuel consumption, select it and while the digits are flashing push the “TRIP” switch until it is reset.

**TIP** \_\_\_\_\_  
After resetting the average fuel consumption, “\_ \_ . \_” will be shown until the vehicle has traveled 1 km (0.6 mi).

## Coolant temperature



1. Coolant temperature display

This display shows the coolant temperature from 40 °C to 116 °C in 1 °C increments.

# Instrument and control functions

If the message “Hi” flashes, stop the vehicle, then stop the engine, and let it cool. (See page 6-36.)

## TIP

- When the coolant temperature is below 40 °C, “Lo” will be displayed.
- The coolant temperature varies with changes in the weather and engine load.

## Air temperature

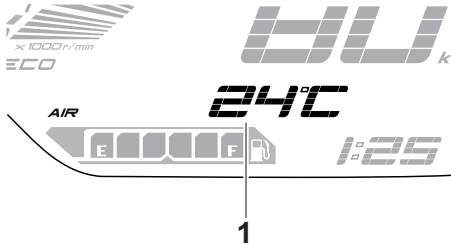

1. Air temperature display

This display shows the air temperature from -9 °C to 99 °C in 1 °C increments. The temperature displayed may vary from the ambient temperature.

**TIP**  
When the temperature is below -9 °C, “Lo” will be displayed.

## Brightness control mode

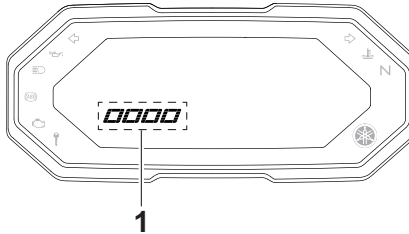

1. Brightness level display

The brightness level of the multi-function meter unit panel can be adjusted.

## To adjust the brightness

1. Turn the key to “OFF”.
2. Push and hold the “INFO” switch.
3. Turn the key to “ON” and continue pushing the “INFO” switch until the display switches to the brightness control mode.
4. Push the “TRIP” switch to set the brightness level.

5. Push the “INFO” switch to confirm the selected brightness level and exit the brightness control mode.

**TIP**  
There are 4 brightness level settings.

## Handlebar switches

EAU1234N

### Left

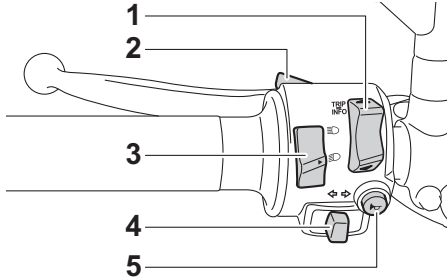

1. "TRIP/INFO" switch
2. Pass switch "≡○"
3. Dimmer switch "≡○/≡○"
4. Turn signal switch "↔/↔"
5. Horn switch "📢"

### Right

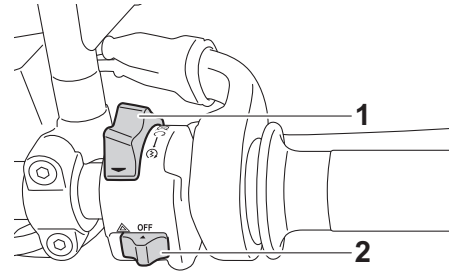

1. Start/Engine stop switch "🛑/○/🛑"
2. Hazard lights switch "⚠️/OFF"

### Pass switch "≡○"

EAU12381

Press this switch to flash the headlights.

### Dimmer switch "≡○/≡○"

EAU85410

Set this switch to "≡○" for the high beam and to "≡○" for the low beam.

### TIP

When the switch is set to low beam, both headlights for low beam come on. When the switch is set to high beam, both headlights for high beam come on.

### Turn signal switch "↔/↔"

EAU12461

To signal a right-hand turn, push this switch to "↔". To signal a left-hand turn, push this switch to "↔". When released, the switch returns to the center position. To cancel the turn signal lights, push the switch in after it has returned to the center position.

### Horn switch "📢"

EAU12501

Press this switch to sound the horn.

### Start/Engine stop switch "🛑/○/🛑"

EAU68271

To crank the engine with the starter, set this switch to "○", and then slide the switch toward "🛑". See page 5-2 for starting instructions prior to starting the engine.

Set this switch to "🛑" to stop the engine in case of an emergency, such as when the vehicle overturns or when the throttle cable is stuck.

### Hazard lights switch "⚠️/OFF"

EAUM1992

The hazard lights (simultaneous flashing of all turn signal lights) are used in case of an emergency such as to warn

# Instrument and control functions

3

other drivers when your vehicle is stopped where it might be a traffic hazard.

With the main switch in the on position, set the hazard lights switch to “ $\Delta$ ” to turn on the hazard lights. The main switch can then be turned to the off position or lock position, however the hazard lights will continue flash. To turn off the hazard lights, turn the main switch to the on position and set this switch to “OFF”.

ECA10062

## NOTICE

**Do not use the hazard lights for an extended length of time with the engine not running, otherwise the battery may discharge.**

EAUM3720

## Trip/info switch “TRIP/INFO”

This switch is used to make setting and display changes in the multi-function meter unit. See page 3-6 for more information.

## Clutch lever

EAU12823

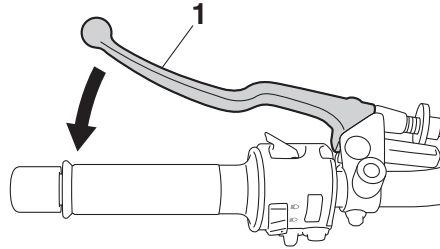

1. Clutch lever

To disengage the drivetrain from the engine, such as when shifting gears, pull the clutch lever toward the handlebar. Release the lever to engage the clutch and transmit power to the rear wheel.

## TIP

The lever should be pulled rapidly and released slowly for smooth shifting. (See page 5-3.)

## Shift pedal

EAU12876

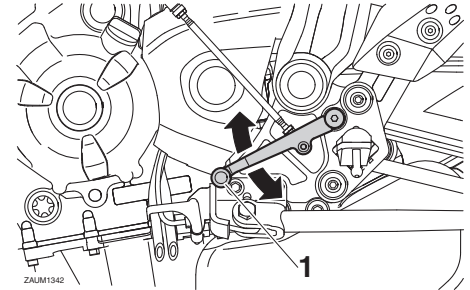

1. Shift pedal

The shift pedal is located on the left side of the motorcycle. To shift the transmission to a higher gear, move the shift pedal up. To shift the transmission to a lower gear, move the shift pedal down. (See page 5-3.)

EAU26827

## Brake lever

The brake lever is located on the right side of the handlebar. To apply the front brake, pull the lever toward the throttle grip.

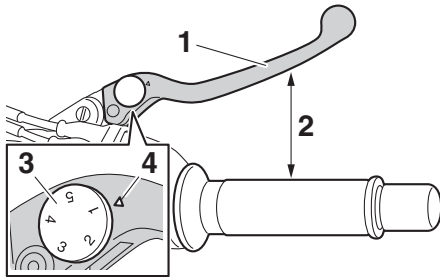

1. Brake lever
2. Distance between brake lever and throttle grip
3. Brake lever position adjusting dial
4. Match mark

The brake lever is equipped with a brake lever position adjusting dial. To adjust the distance between the brake lever and the throttle grip, push the brake lever away from the throttle grip and rotate the adjusting dial. Make sure the setting number on the adjusting dial aligns with the match mark on the brake lever.

EAU12944

## Brake pedal

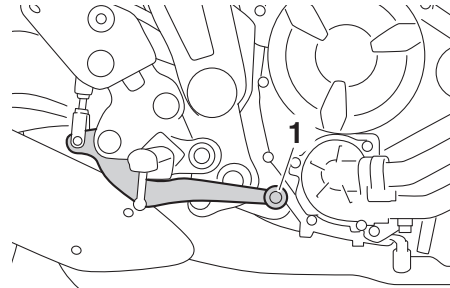

1. Brake pedal

The brake pedal is located on the right side of the motorcycle. To apply the rear brake, press down on the brake pedal.

EAU63040

## ABS

The Yamaha ABS (Anti-lock Brake System) features a dual electronic control system, which acts on the front and rear brakes independently.

Operate the brakes with ABS as you would conventional brakes. If the ABS is activated, a pulsating sensation may be felt at the brake lever or brake pedal. In this situation, continue to apply the brakes and let the ABS work; do not “pump” the brakes as this will reduce braking effectiveness.

EWA16051

### **WARNING**

**Always keep a sufficient distance from the vehicle ahead to match the riding speed even with ABS.**

- **The ABS performs best with long braking distances.**
- **On certain surfaces, such as rough or gravel roads, the braking distance may be longer with the ABS than without.**

The ABS is monitored by an ECU, which will revert the system to conventional braking if a malfunction occurs.

# Instrument and control functions

## TIP

- The ABS performs a self-diagnosis test each time the vehicle first starts off after the key is turned to “ON” and the vehicle has traveled at a speed of 10 km/h (6 mi/h) or higher. During this test, a “clicking” noise can be heard from the hydraulic control unit, and if the brake lever or brake pedal is even slightly applied, a vibration can be felt at the lever and pedal, but these do not indicate a malfunction.
- This ABS has a test mode which allows the owner to experience the pulsation at the brake lever or brake pedal when the ABS is operating. However, special tools are required, so please consult your Yamaha dealer.

## NOTICE

**Be careful not to damage the wheel sensor or wheel sensor rotor; otherwise, improper performance of the ABS will result.**

ECA20100

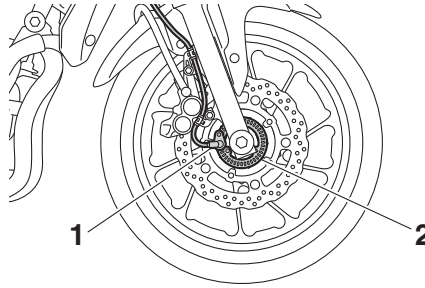

1. Front wheel sensor
2. Front wheel sensor rotor

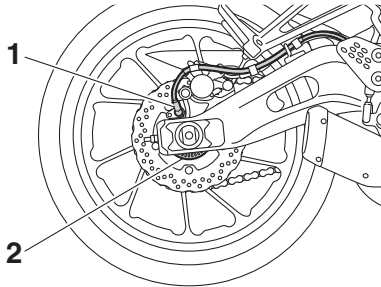

1. Rear wheel sensor
2. Rear wheel sensor rotor

## Fuel tank cap

EAU13077

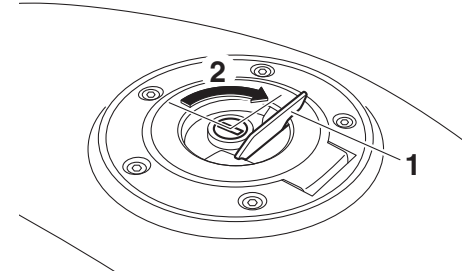

1. Fuel tank cap lock cover
2. Unlock.

### To open the fuel tank cap

Open the fuel tank cap lock cover, insert the key, and then turn it 1/4 turn clockwise. The lock will be released and the fuel tank cap can be opened.

### To close the fuel tank cap

With the key still inserted, push down the fuel tank cap. Turn the key 1/4 turn counterclockwise, remove it, and then close the lock cover.

## TIP

The fuel tank cap cannot be closed unless the key is in the lock. In addition, the key cannot be removed if the cap is not properly closed and locked.

## WARNING

Make sure that the fuel tank cap is properly closed after filling fuel. Leaking fuel is a fire hazard.

EWA11092

## Fuel

Make sure there is sufficient gasoline in the tank.

## WARNING

Gasoline and gasoline vapors are extremely flammable. To avoid fires and explosions and to reduce the risk of injury when refueling, follow these instructions.

1. Before refueling, turn off the engine and be sure that no one is sitting on the vehicle. Never refuel while smoking, or while in the vicinity of sparks, open flames, or other sources of ignition such as the pilot lights of water heaters and clothes dryers.
2. Do not overfill the fuel tank. When refueling, be sure to insert the pump nozzle into the fuel tank filler hole. Stop filling when the fuel reaches the bottom of the filler tube. Because fuel expands when it heats up, heat from the engine or the sun can cause fuel to spill out of the fuel tank.

EAU13222

EWA10882

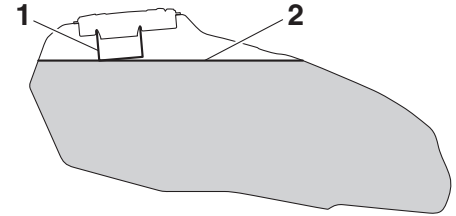

1. Fuel tank filler tube
2. Maximum fuel level
3. Wipe up any spilled fuel immediately. **NOTICE: Immediately wipe off spilled fuel with a clean, dry, soft cloth, since fuel may deteriorate painted surfaces or plastic parts.** [ECA10072]
4. Be sure to securely close the fuel tank cap.

## WARNING

Gasoline is poisonous and can cause injury or death. Handle gasoline with care. Never siphon gasoline by mouth. If you should swallow some gasoline or inhale a lot of gasoline vapor, or get some gasoline in your eyes, see your doctor immediately. If

EWA15152

# Instrument and control functions

ECA11401

gasoline spills on your skin, wash with soap and water. If gasoline spills on your clothing, change your clothes.

3

EAU86072

Your Yamaha engine was designed to use unleaded gasoline with a research octane number of 95 or higher. If engine knocking or pinging occurs, use a gasoline of a different brand or higher octane rating.

**Recommended fuel:**

Unleaded gasoline (E10 acceptable)

**Octane number (RON):**

95

**Fuel tank capacity:**

17.0 L (4.49 US gal, 3.74 Imp.gal)

**Fuel tank reserve:**

3.5 L (0.92 US gal, 0.77 Imp.gal)

**TIP**

- This mark identifies the recommended fuel for this vehicle as specified by European regulation (EN228).
- Confirm the gasoline pump nozzle has the same fuel identification mark.

**Gasohol**

There are two types of gasohol: gasohol containing ethanol and that containing methanol. Gasohol containing ethanol can be used if the ethanol content does not exceed 10% (E10). Gasohol containing methanol is not recommended by Yamaha because it can cause damage to the fuel system or vehicle performance problems.

**NOTICE**

Use only unleaded gasoline. The use of leaded gasoline will cause severe damage to internal engine parts, such as the valves and piston rings, as well as to the exhaust system.



## Fuel tank breather hose and overflow hose

EAU86240

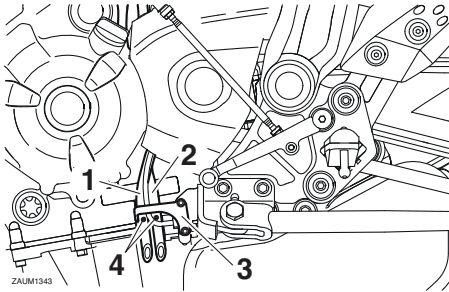

1. Fuel tank overflow hose
2. Fuel tank breather hose
3. Clamp
4. Original position (paint mark)

The breather hose prevents a vacuum condition from forming within the fuel tank.

The overflow hose drains excess gasoline and directs it safely away from the vehicle.

Before operating the vehicle:

- Check each hose connection.
- Check each hose for cracks or damage, and replace if necessary.

- Make sure that the end of each hose is not blocked, and clean if necessary.
- Make sure that each hose is positioned as shown.

## Catalytic converter

EAU13435

The exhaust system contains catalytic converter(s) to reduce harmful exhaust emissions.

EWA10863

### **⚠ WARNING**

The exhaust system is hot after operation. To prevent a fire hazard or burns:

- Do not park the vehicle near possible fire hazards such as grass or other materials that easily burn.
- Park the vehicle in a place where pedestrians or children are not likely to touch the hot exhaust system.
- Make sure that the exhaust system has cooled down before doing any maintenance work.
- Do not allow the engine to idle more than a few minutes. Long idling can cause a build-up of heat.

# Instrument and control functions

## Seat

EAUM3740

### To remove the seat

Insert the key into the seat lock, turn it counterclockwise, and then pull the seat off.

3

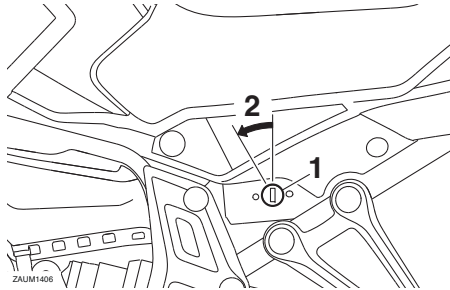

1. Seat lock
2. Unlock.

### To install the seat

Insert the projection on the front of the seat into the seat holder, orient the seat in order to insert the seat bracket into the seat lock, push the rear of the seat down to lock it in place, and then remove the key.

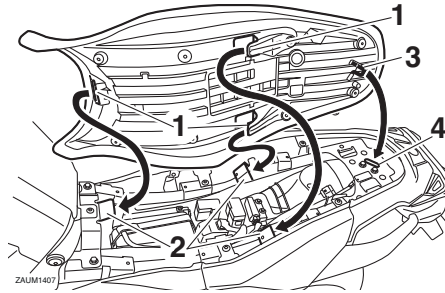

1. Projection
2. Seat holder
3. Seat bracket
4. Seat lock

### TIP

Make sure that the seat is properly secured before riding.

EAUM3800

## Helmet holding cable

The helmet holder is located under the seat. A helmet holding cable is provided in the owner's tool kit to secure a helmet to the helmet holder.

### To secure a helmet with the helmet holding cable

1. Remove the seat. (See page 3-19.)
2. Pass the helmet holding cable through the buckle on the helmet strap buckle as shown, and then hook the cable loops over the helmet holder.

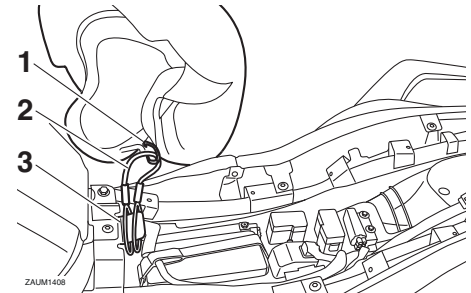

1. Helmet strap buckle
2. Helmet holding cable
3. Helmet holder

- Place the helmet on the left or the right side of the vehicle or on the top of the fuel tank, and then install the seat. **WARNING! Never ride with a helmet attached to the helmet holder, since the helmet may hit objects, causing loss of control and possibly an accident.** [EWA10162]

## To release the helmet from the helmet holding cable

Remove the seat, remove the helmet holding cable from the helmet holder and the helmet, and then install the seat.

## Storage compartment

EAU14465

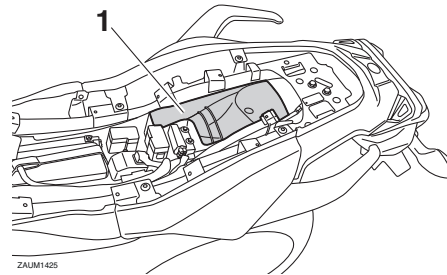

1. Storage compartment

The storage compartment is located under the passenger seat.

When storing documents or other items in the storage compartment, be sure to wrap them in a plastic bag so that they will not get wet. When washing the vehicle, be careful not to let any water enter the storage compartment.

EWA10962

## **! WARNING**

- Do not exceed the load limit of 1.5 kg (3.3 lb) for the storage compartment.
- Do not exceed the maximum load of 181 kg (399 lb) for the vehicle.

## Windshield

EAU4230

This model is equipped with an adjustable windshield.

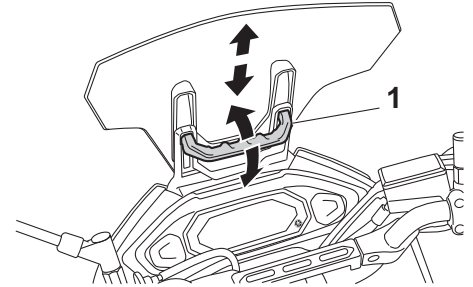

1. Windshield lock

To change the position of the windshield, lift up the windshield lock handle and slide the windshield up or down. Push down the lock handle when finished.

## **TIP**

Make sure the windshield and lock handle are properly secured before riding.

# Instrument and control functions

3

## Adjusting the front fork

EAUM4241

The front fork is equipped with spring preload adjusting bolts and rebound damping force adjusting screws.

ECA10102

### NOTICE

To avoid damaging the mechanism, do not attempt to turn beyond the maximum or minimum settings.

EWA10181

### WARNING

Always adjust both fork legs equally, otherwise poor handling and loss of stability may result.

## Spring preload

Turn the adjusting bolt in direction (a) to increase the spring preload.

Turn the adjusting bolt in direction (b) to decrease the spring preload.

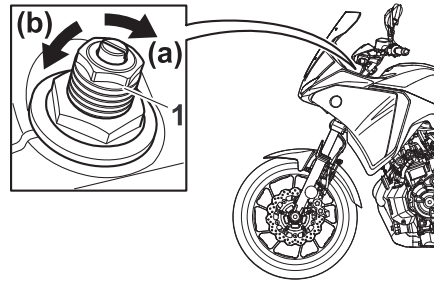

1. Spring preload adjusting bolt

The spring preload setting is determined by measuring distance A, shown in the illustration. The shorter distance A is, the higher the spring preload; the longer distance A is, the lower the spring preload.

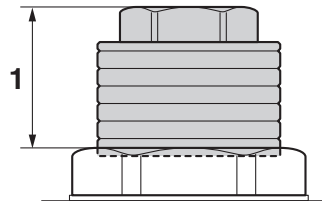

1. Distance A

## Spring preload setting:

- Minimum (soft):  
Distance A = 20.0 mm (0.79 in)
- Standard:  
Distance A = 15.0 mm (0.59 in)
- Maximum (hard):  
Distance A = 5.0 mm (0.20 in)

## Rebound damping force

Turn the adjusting screw in direction (a) to increase the rebound damping force.

Turn the adjusting screw in direction (b) to decrease the rebound damping force.

To set the rebound damping force, turn the adjuster in direction (a) until it stops, and then count the clicks in direction (b).

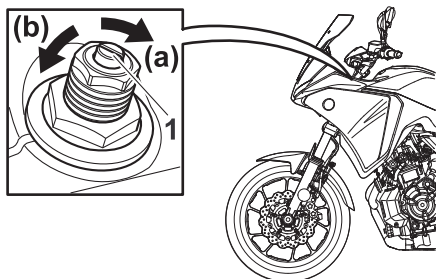

1. Rebound damping force adjusting screw

### Rebound damping setting:

Minimum (soft):

10 click(s) in direction (b)

Standard:

6 click(s) in direction (b)

Maximum (hard):

0 click(s) in direction (b)

### TIP

- When turning the damping force adjuster in direction (a), the 0 click position and the 1 click position may be the same.
- When turning the damping force adjuster in direction (b), it may click beyond the stated specifica-

tions, however such adjustments are ineffective and may damage the suspension.

## Adjusting the shock absorber assembly

This shock absorber assembly is equipped with a spring preload adjusting ring and a rebound damping force adjusting screw.

ECA10102

### NOTICE

**To avoid damaging the mechanism, do not attempt to turn beyond the maximum or minimum settings.**

### Spring preload

Turn the adjusting ring in direction (a) to increase the spring preload.

Turn the adjusting ring in direction (b) to decrease the spring preload.

Align the appropriate notch in the adjusting ring with the position indicator on the shock absorber.

# Instrument and control functions

3

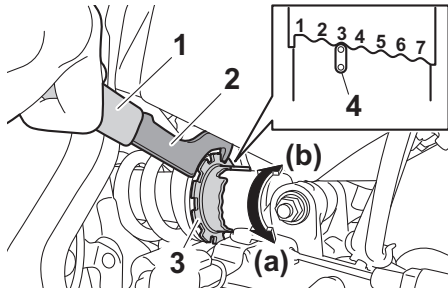

1. Extension bar
2. Special wrench
3. Spring preload adjusting ring
4. Position indicator

## TIP

Use the special wrench and extension bar in the tool kit to make this adjustment.

### Spring preload setting:

Minimum (soft):

1

Standard:

4

Maximum (hard):

7

## Rebound damping force

Turn the adjusting screw in direction (a) to increase the rebound damping force.

Turn the adjusting screw in direction (b) to decrease the rebound damping force.

To set the rebound damping force, turn the adjuster in direction (a) until it stops, and then count the turns in direction (b).

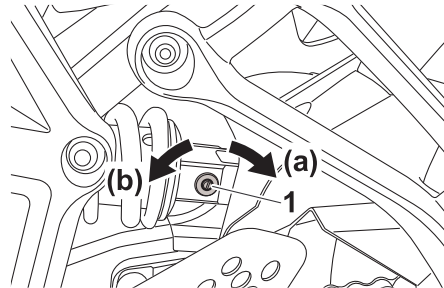

1. Rebound damping force adjusting screw

### Rebound damping setting:

Minimum (soft):

2.5 turn(s) in direction (b)

Standard:

1 1/4 turn(s) in direction (b)

Maximum (hard):

0 turn(s) in direction (b)

## TIP

When turning the damping force adjuster in direction (b), it may turn beyond the stated specifications, however such adjustments are ineffective and may damage the suspension.

## WARNING

EWA10222

This shock absorber assembly contains highly pressurized nitrogen gas. Read and understand the following information before handling the shock absorber assembly.

- Do not tamper with or attempt to open the cylinder assembly.
- Do not subject the shock absorber assembly to an open flame or other high heat source. This may cause the unit to explode due to excessive gas pressure.
- Do not deform or damage the cylinder in any way. Cylinder damage will result in poor damping performance.

- Do not dispose of a damaged or worn-out shock absorber assembly yourself. Take the shock absorber assembly to a Yamaha dealer for any service.

## Luggage strap holders

EAU84680

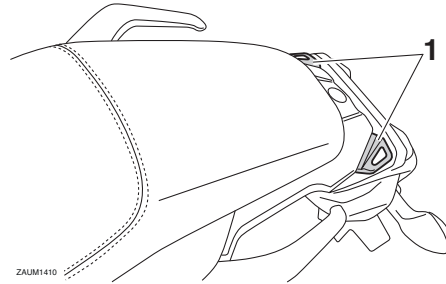

1. Luggage strap holder

Use the indicated strap points to secure luggage ties to the vehicle.

## Auxiliary DC connector

EAU70641

This vehicle is equipped with an auxiliary DC connector. Consult your Yamaha dealer before installing any accessories.

# Instrument and control functions

---

3

## Sidestand

EAU15306

The sidestand is located on the left side of the frame. Raise the sidestand or lower it with your foot while holding the vehicle upright.

### TIP

The built-in sidestand switch is part of the ignition circuit cut-off system, which cuts the ignition in certain situations. (See the following section for an explanation of the ignition circuit cut-off system.)

EWA10242

### WARNING

**The vehicle must not be ridden with the sidestand down, or if the sidestand cannot be properly moved up (or does not stay up), otherwise the sidestand could contact the ground and distract the operator, resulting in a possible loss of control. Yamaha's ignition circuit cut-off system has been designed to assist the operator in fulfilling the responsibility of raising the sidestand before starting off. Therefore, check**

**this system regularly and have a Yamaha dealer repair it if it does not function properly.**

---

EAU44895

## Ignition circuit cut-off system

This system prevents in-gear engine starts unless the clutch lever is pulled and the sidestand is up. Also, it will stop the running engine should the sidestand be lowered while the transmission is in gear.

Periodically check the system via the following procedure.

### TIP

- This check is most reliable if performed with a warmed-up engine.
  - See pages 3-2 and 3-12 for switch operation information.
-



With the engine turned off:  
1. Move the sidestand down.  
2. Set engine stop switch to run position.  
3. Turn main switch to on position.  
4. Shift transmission into neutral.  
5. Push the start switch.  
**Does the engine start?**

YES NO

With the engine still running:  
6. Move the sidestand up.  
7. Pull the clutch lever.  
8. Shift transmission into gear.  
9. Move the sidestand down.  
**Does the engine stall?**

YES NO

After the engine has stalled:  
10. Move the sidestand up.  
11. Pull the clutch lever.  
12. Push the start switch.  
**Does the engine start?**

YES NO

The system is OK. **The motorcycle can be ridden.**



**WARNING**

**If a malfunction is found, have the vehicle inspected before riding.**

The neutral switch may not be working.  
**The motorcycle should not be ridden** until checked by a Yamaha dealer.

The sidestand switch may not be working.  
**The motorcycle should not be ridden** until checked by a Yamaha dealer.

The clutch switch may not be working.  
**The motorcycle should not be ridden** until checked by a Yamaha dealer.

# For your safety – pre-operation checks

EAU1559A

Inspect your vehicle each time you use it to make sure the vehicle is in safe operating condition. Always follow the inspection and maintenance procedures and schedules described in the Owner's Manual.

EWA11152

## **WARNING**

**Failure to inspect or maintain the vehicle properly increases the possibility of an accident or equipment damage. Do not operate the vehicle if you find any problem. If a problem cannot be corrected by the procedures provided in this manual, have the vehicle inspected by a Yamaha dealer.**

4

Before using this vehicle, check the following points:

ITEM	CHECKS	PAGE
Fuel	<ul style="list-style-type: none"><li>• Check fuel level in fuel tank.</li><li>• Refuel if necessary.</li><li>• Check fuel line for leakage.</li><li>• Check fuel tank breather hose and overflow hose for obstructions, cracks or damage, and check hose connections.</li></ul>	3-16, 3-18
Engine oil	<ul style="list-style-type: none"><li>• Check oil level in engine.</li><li>• If necessary, add recommended oil to specified level.</li><li>• Check vehicle for oil leakage.</li></ul>	6-10
Coolant	<ul style="list-style-type: none"><li>• Check coolant level in reservoir.</li><li>• If necessary, add recommended coolant to specified level.</li><li>• Check cooling system for leakage.</li></ul>	6-13
Front brake	<ul style="list-style-type: none"><li>• Check operation.</li><li>• If soft or spongy, have Yamaha dealer bleed hydraulic system.</li><li>• Check brake pads for wear.</li><li>• Replace if necessary.</li><li>• Check fluid level in reservoir.</li><li>• If necessary, add specified brake fluid to specified level.</li><li>• Check hydraulic system for leakage.</li></ul>	6-20, 6-21

# For your safety – pre-operation checks

ITEM	CHECKS	PAGE
<b>Rear brake</b>	<ul style="list-style-type: none"> <li>• Check operation.</li> <li>• If soft or spongy, have Yamaha dealer bleed hydraulic system.</li> <li>• Check brake pads for wear.</li> <li>• Replace if necessary.</li> <li>• Check fluid level in reservoir.</li> <li>• If necessary, add specified brake fluid to specified level.</li> <li>• Check hydraulic system for leakage.</li> </ul>	6-20, 6-21
<b>Clutch</b>	<ul style="list-style-type: none"> <li>• Check operation.</li> <li>• Lubricate cable if necessary.</li> <li>• Check lever free play.</li> <li>• Adjust if necessary.</li> </ul>	6-19
<b>Throttle grip</b>	<ul style="list-style-type: none"> <li>• Make sure that operation is smooth.</li> <li>• Check throttle grip free play.</li> <li>• If necessary, have Yamaha dealer adjust throttle grip free play and lubricate cable and grip housing.</li> </ul>	6-15, 6-25
<b>Control cables</b>	<ul style="list-style-type: none"> <li>• Make sure that operation is smooth.</li> <li>• Lubricate if necessary.</li> </ul>	6-25
<b>Drive chain</b>	<ul style="list-style-type: none"> <li>• Check chain slack.</li> <li>• Adjust if necessary.</li> <li>• Check chain condition.</li> <li>• Lubricate if necessary.</li> </ul>	6-23, 6-24
<b>Wheels and tires</b>	<ul style="list-style-type: none"> <li>• Check for damage.</li> <li>• Check tire condition and tread depth.</li> <li>• Check air pressure.</li> <li>• Correct if necessary.</li> </ul>	6-16, 6-18
<b>Brake and shift pedals</b>	<ul style="list-style-type: none"> <li>• Make sure that operation is smooth.</li> <li>• Lubricate pedal pivoting points if necessary.</li> </ul>	6-26
<b>Brake and clutch levers</b>	<ul style="list-style-type: none"> <li>• Make sure that operation is smooth.</li> <li>• Lubricate lever pivoting points if necessary.</li> </ul>	6-26
<b>Sidestand</b>	<ul style="list-style-type: none"> <li>• Make sure that operation is smooth.</li> <li>• Lubricate pivot if necessary.</li> </ul>	6-27

## For your safety – pre-operation checks

ITEM	CHECKS	PAGE
<b>Chassis fasteners</b>	<ul style="list-style-type: none"><li>• Make sure that all nuts, bolts and screws are properly tightened.</li><li>• Tighten if necessary.</li></ul>	–
<b>Instruments, lights, signals and switches</b>	<ul style="list-style-type: none"><li>• Check operation.</li><li>• Correct if necessary.</li></ul>	–
<b>Sidestand switch</b>	<ul style="list-style-type: none"><li>• Check operation of ignition circuit cut-off system.</li><li>• If system is not working correctly, have Yamaha dealer check vehicle.</li></ul>	3-25

EAU15952

Read the Owner's Manual carefully to become familiar with all controls. If there is a control or function you do not understand, ask your Yamaha dealer.

EWA10272



**Failure to familiarize yourself with the controls can lead to loss of control, which could cause an accident or injury.**

EAU16842

## Engine break-in

There is never a more important period in the life of your engine than the period between 0 and 1600 km (1000 mi). For this reason, you should read the following material carefully.

Since the engine is brand new, do not put an excessive load on it for the first 1600 km (1000 mi). The various parts in the engine wear and polish themselves to the correct operating clearances. During this period, prolonged full-throttle operation or any condition that might result in engine overheating must be avoided.

EAU17094

### 0–1000 km (0–600 mi)

Avoid prolonged operation above 5000 r/min. **NOTICE: After 1000 km (600 mi) of operation, the engine oil must be changed and the oil filter cartridge or element replaced.** [ECA10303]

### 1000–1600 km (600–1000 mi)

Avoid prolonged operation above 6000 r/min.

### 1600 km (1000 mi) and beyond

The vehicle can now be operated normally.

ECA10311

#### **NOTICE**

- **Keep the engine speed out of the tachometer red zone.**
- **If any engine trouble should occur during the engine break-in period, immediately have a Yamaha dealer check the vehicle.**

# Operation and important riding points

---

## Starting the engine

EAU86620

The ignition circuit cut-off system will enable starting when:

- the transmission is in the neutral position or
- the transmission is in gear, the sidestand is up, and the clutch lever is pulled.

5

### To start the engine

1. Turn the main switch on and set the engine stop switch to the run position.
2. Confirm the indicator and warning light(s) come on for a few seconds, and the go off. (See page 3-3.)

### TIP

- Do not start the engine if the engine trouble warning light remains on.
- The oil pressure warning light should come on and stay on until the engine is started.

- The ABS warning light should come on and stay on until the vehicle reaches a speed of 10 km/h (6 mi/h).

EAUM3632

ECA24110

### **NOTICE**

**If a warning or indicator light does not work as described above, have a Yamaha dealer check the vehicle.**

3. Shift the transmission into the neutral position.
4. Start the engine by pushing the start switch.
5. Release the start switch when the engine starts, or after 5 seconds. Wait 10 seconds before pressing the switch again to allow battery voltage to restore.

ECA11043

### **NOTICE**

**For maximum engine life, never accelerate hard when the engine is cold!**

### **TIP**

This model is equipped with:

- a lean angle sensor. This sensor stops the engine in case of a vehicle turnover. If this happens, the engine trouble warning light will come on, but this is not a malfunction. Turn the vehicle power off and then back on again to cancel the warning light. Failing to do so will prevent the engine from starting even though the engine will crank when pushing the start switch.
- an engine auto-stop system. The engine stops automatically if left idling for 20 minutes. If the engine stops, simply push the start switch to restart the engine.

## Shifting

EAU16674

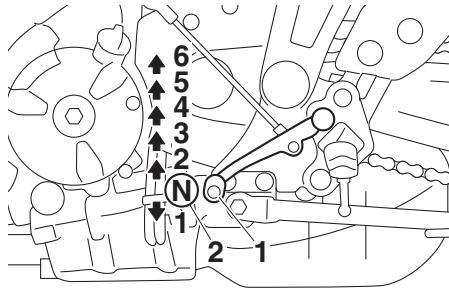

1. Shift pedal
2. Neutral position

Shifting gears lets you control the amount of engine power available for starting off, accelerating, climbing hills, etc.

The gear positions are shown in the illustration.

### TIP

To shift the transmission into the neutral position (N), press the shift pedal down repeatedly until it reaches the end of its travel, and then slightly raise it.

ECA10261

### NOTICE

- **Even with the transmission in the neutral position, do not coast for long periods of time with the engine off, and do not tow the motorcycle for long distances. The transmission is properly lubricated only when the engine is running. Inadequate lubrication may damage the transmission.**
- **Always use the clutch while changing gears to avoid damaging the engine, transmission, and drive train, which are not designed to withstand the shock of forced shifting.**

EAU85370

### To start out and accelerate

1. Pull the clutch lever to disengage the clutch.
2. Shift the transmission into first gear. The neutral indicator light should go out.
3. Open the throttle gradually, and at the same time, release the clutch lever slowly.

4. After starting out, close the throttle, and at the same time, quickly pull the clutch lever in.
5. Shift the transmission into second gear. (Make sure not to shift the transmission into the neutral position.)
6. Open the throttle part way and gradually release the clutch lever.
7. Follow the same procedure when shifting to the next higher gear.

5

EAU85380

### To decelerate

1. Release the throttle and apply both the front and the rear brakes smoothly to slow the motorcycle.
2. As the vehicle decelerates, shift to a lower gear.
3. When the engine is about to stall or runs roughly, pull the clutch lever in, use the brakes to slow the motorcycle, and continue to downshift as necessary.
4. Once the motorcycle has stopped, the transmission can be shifted into the neutral position.

# Operation and important riding points

---

The neutral indicator light should come on and then the clutch lever can be released.

EWA17380

## **WARNING**

- **Improper braking can cause loss of control or traction. Always use both brakes and apply them smoothly.**
  - **Make sure that the motorcycle and the engine have sufficiently slowed before shifting to a lower gear. Engaging a lower gear when the vehicle or engine speed is too high could make the rear wheel lose traction or the engine to over-rev. This could cause loss of control, an accident and injury. It could also cause engine or drive train damage.**
- 

EAU16811

## **Tips for reducing fuel consumption**

Fuel consumption depends largely on your riding style. Consider the following tips to reduce fuel consumption:

- Shift up swiftly, and avoid high engine speeds during acceleration.
- Do not rev the engine while shifting down, and avoid high engine speeds with no load on the engine.
- Turn the engine off instead of letting it idle for an extended length of time (e.g., in traffic jams, at traffic lights or at railroad crossings).

EAU17214

## **Parking**

When parking, stop the engine, and then remove the key from the main switch.

EWA10312

## **WARNING**

- **Since the engine and exhaust system can become very hot, park in a place where pedestrians or children are not likely to touch them and be burned.**
  - **Do not park on a slope or on soft ground, otherwise the vehicle may overturn, increasing the risk of a fuel leak and fire.**
  - **Do not park near grass or other flammable materials which might catch fire.**
-



EAU17246

EWA15123

EAU17303

Periodic inspection, adjustment, and lubrication will keep your vehicle in the safest and most efficient condition possible. Safety is an obligation of the vehicle owner/operator. The most important points of vehicle inspection, adjustment, and lubrication are explained on the following pages.

The intervals given in the periodic maintenance charts should be simply considered as a general guide under normal riding conditions. However, depending on the weather, terrain, geographical location, and individual use, the maintenance intervals may need to be shortened.

EWA10322

EWA15461

## **WARNING**

**Failure to properly maintain the vehicle or performing maintenance activities incorrectly may increase your risk of injury or death during service or while using the vehicle. If you are not familiar with vehicle service, have a Yamaha dealer perform service.**

## **WARNING**

**Turn off the engine when performing maintenance unless otherwise specified.**

- **A running engine has moving parts that can catch on body parts or clothing and electrical parts that can cause shocks or fires.**
- **Running the engine while servicing can lead to eye injury, burns, fire, or carbon monoxide poisoning – possibly leading to death. See page 1-3 for more information about carbon monoxide.**

## **WARNING**

**Brake discs, calipers, drums, and linings can become very hot during use. To avoid possible burns, let brake components cool before touching them.**

Emission controls not only function to ensure cleaner air, but are also vital to proper engine operation and maximum performance. In the following periodic maintenance charts, the services related to emissions control are grouped separately. These services require specialized data, knowledge, and equipment. Maintenance, replacement, or repair of the emission control devices and systems may be performed by any repair establishment or individual that is certified (if applicable). Yamaha dealers are trained and equipped to perform these particular services.

# Periodic maintenance and adjustment

---

EAU85230

## Tool kit

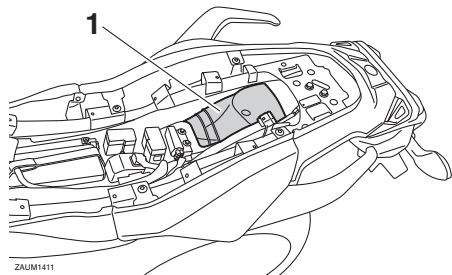

ZAUM1411

### 1. Tool kit

6

The tool kit is in the location shown. The information included in this manual and the tools provided in the tool kit are intended to assist you in the performance of preventive maintenance and minor repairs. However, a torque wrench and other tools are necessary to perform certain maintenance work correctly.

### **TIP** \_\_\_\_\_

If you do not have the tools or experience required for a particular job, have your Yamaha dealer perform it for you.

---

# Periodic maintenance and adjustment

EAU71031

## Periodic maintenance charts

### TIP

- Items marked with an asterisk should be performed by your Yamaha dealer because these items require special tools, data, and technical skills.
- From 50000 km (30000 mi), repeat the maintenance intervals starting from 10000 km (6000 mi).
- **The annual checks must be performed every year, except if a distance-based maintenance is performed instead.**

EAU71051

## Periodic maintenance chart for the emission control system

NO.	ITEM	CHECK OR MAINTENANCE JOB	ODOMETER READING					ANNUAL CHECK
			1000 km (600 mi)	10000 km (6000 mi)	20000 km (12000 mi)	30000 km (18000 mi)	40000 km (24000 mi)	
1	* Fuel line	<ul style="list-style-type: none"> <li>• Check fuel hoses for cracks or damage.</li> <li>• Replace if necessary.</li> </ul>		√	√	√	√	√
2	* Spark plugs	<ul style="list-style-type: none"> <li>• Check condition.</li> <li>• Adjust gap and clean.</li> </ul>		√		√		
		<ul style="list-style-type: none"> <li>• Replace.</li> </ul>			√		√	
3	* Valve clearance	<ul style="list-style-type: none"> <li>• Check and adjust.</li> </ul>	Every 40000 km (24000 mi)					
4	* Fuel injection	<ul style="list-style-type: none"> <li>• Check engine idle speed.</li> </ul>	√	√	√	√	√	√
		<ul style="list-style-type: none"> <li>• Check and adjust synchronization.</li> </ul>		√	√	√	√	√
5	* Exhaust system	<ul style="list-style-type: none"> <li>• Check for leakage.</li> <li>• Tighten if necessary.</li> <li>• Replace gaskets if necessary.</li> </ul>	√	√	√	√	√	

# Periodic maintenance and adjustment

NO.	ITEM	CHECK OR MAINTENANCE JOB	ODOMETER READING					ANNUAL CHECK
			1000 km (600 mi)	10000 km (6000 mi)	20000 km (12000 mi)	30000 km (18000 mi)	40000 km (24000 mi)	
6	*	<b>Evaporative emission control system</b>			√		√	

# Periodic maintenance and adjustment

EAU71353

## General maintenance and lubrication chart

NO.	ITEM	CHECK OR MAINTENANCE JOB	ODOMETER READING					ANNUAL CHECK
			1000 km (600 mi)	10000 km (6000 mi)	20000 km (12000 mi)	30000 km (18000 mi)	40000 km (24000 mi)	
1	* Diagnostic system check	<ul style="list-style-type: none"> <li>Perform dynamic inspection using Yamaha diagnostic tool.</li> <li>Check the error codes.</li> </ul>	√	√	√	√	√	√
2	* Air filter element	<ul style="list-style-type: none"> <li>Replace.</li> </ul>	Every 40000 km (24000 mi)					
3	Air filter case check hose	<ul style="list-style-type: none"> <li>Clean.</li> </ul>	√	√	√	√	√	
4	Clutch	<ul style="list-style-type: none"> <li>Check operation.</li> <li>Adjust.</li> </ul>	√	√	√	√	√	
5	* Front brake	<ul style="list-style-type: none"> <li>Check operation, fluid level, and for fluid leakage.</li> <li>Replace brake pads if necessary.</li> </ul>	√	√	√	√	√	√
6	* Rear brake	<ul style="list-style-type: none"> <li>Check operation, fluid level, and for fluid leakage.</li> <li>Replace brake pads if necessary.</li> </ul>	√	√	√	√	√	√
7	* Brake hoses	<ul style="list-style-type: none"> <li>Check for cracks or damage.</li> </ul>		√	√	√	√	√
		<ul style="list-style-type: none"> <li>Replace.</li> </ul>	Every 4 years					
8	* Brake fluid	<ul style="list-style-type: none"> <li>Change.</li> </ul>	Every 2 years					
9	* Wheels	<ul style="list-style-type: none"> <li>Check runout and for damage.</li> <li>Replace if necessary.</li> </ul>		√	√	√	√	
10	* Tires	<ul style="list-style-type: none"> <li>Check tread depth and for damage.</li> <li>Replace if necessary.</li> <li>Check air pressure.</li> <li>Correct if necessary.</li> </ul>		√	√	√	√	√

# Periodic maintenance and adjustment

NO.	ITEM	CHECK OR MAINTENANCE JOB	ODOMETER READING					ANNUAL CHECK
			1000 km (600 mi)	10000 km (6000 mi)	20000 km (12000 mi)	30000 km (18000 mi)	40000 km (24000 mi)	
11	* <b>Wheel bearings</b>	<ul style="list-style-type: none"> <li>• Check bearing for looseness or damage.</li> </ul>		√	√	√	√	
12	* <b>Swingarm pivot bearings</b>	<ul style="list-style-type: none"> <li>• Check operation and for excessive play.</li> </ul>		√	√	√	√	
		<ul style="list-style-type: none"> <li>• Lubricate with lithium-soap-based grease.</li> </ul>	Every 50000 km (30000 mi)					
13	<b>Drive chain</b>	<ul style="list-style-type: none"> <li>• Check chain slack, alignment and condition.</li> <li>• Adjust and lubricate chain with a special O-ring chain lubricant thoroughly.</li> </ul>	Every 1000 km (600 mi) and after washing the motorcycle, riding in the rain or riding in wet areas					
14	* <b>Steering bearings</b>	<ul style="list-style-type: none"> <li>• Check bearing assemblies for looseness.</li> </ul>	√	√		√		
		<ul style="list-style-type: none"> <li>• Moderately repack with lithium-soap-based grease.</li> </ul>			√		√	
15	* <b>Chassis fasteners</b>	<ul style="list-style-type: none"> <li>• Make sure that all nuts, bolts and screws are properly tightened.</li> </ul>		√	√	√	√	√
16	<b>Brake lever pivot shaft</b>	<ul style="list-style-type: none"> <li>• Lubricate with silicone grease.</li> </ul>		√	√	√	√	√
17	<b>Brake pedal pivot shaft</b>	<ul style="list-style-type: none"> <li>• Lubricate with lithium-soap-based grease.</li> </ul>		√	√	√	√	√
18	<b>Clutch lever pivot shaft</b>	<ul style="list-style-type: none"> <li>• Lubricate with lithium-soap-based grease.</li> </ul>		√	√	√	√	√
19	<b>Shift pedal pivot shaft</b>	<ul style="list-style-type: none"> <li>• Lubricate with lithium-soap-based grease.</li> </ul>		√	√	√	√	√

# Periodic maintenance and adjustment

NO.	ITEM	CHECK OR MAINTENANCE JOB	ODOMETER READING					ANNUAL CHECK
			1000 km (600 mi)	10000 km (6000 mi)	20000 km (12000 mi)	30000 km (18000 mi)	40000 km (24000 mi)	
20	Sidestand	<ul style="list-style-type: none"> <li>• Check operation.</li> <li>• Lubricate with lithium-soap-based grease.</li> </ul>		√	√	√	√	√
21	* Sidestand switch	<ul style="list-style-type: none"> <li>• Check operation and replace if necessary.</li> </ul>	√	√	√	√	√	√
22	* Front fork	<ul style="list-style-type: none"> <li>• Check operation and for oil leakage.</li> <li>• Replace if necessary.</li> </ul>		√	√	√	√	
23	* Shock absorber assembly	<ul style="list-style-type: none"> <li>• Check operation and for oil leakage.</li> <li>• Replace if necessary.</li> </ul>		√	√	√	√	
24	* Rear suspension relay arm and connecting arm pivoting points	<ul style="list-style-type: none"> <li>• Check operation.</li> </ul>		√	√	√	√	
25	Engine oil	<ul style="list-style-type: none"> <li>• Change (warm engine before draining).</li> <li>• Check oil level and vehicle for oil leakage.</li> </ul>	√	√	√	√	√	√
26	Engine oil filter cartridge	<ul style="list-style-type: none"> <li>• Replace.</li> </ul>	√		√		√	
27	* Cooling system	<ul style="list-style-type: none"> <li>• Check coolant level and vehicle for coolant leakage.</li> </ul>		√	√	√	√	√
		<ul style="list-style-type: none"> <li>• Change.</li> </ul>	Every 3 years					
28	* Front and rear brake switches	<ul style="list-style-type: none"> <li>• Check operation.</li> </ul>	√	√	√	√	√	√
29	* Moving parts and cables	<ul style="list-style-type: none"> <li>• Lubricate.</li> </ul>		√	√	√	√	√

# Periodic maintenance and adjustment

NO.	ITEM	CHECK OR MAINTENANCE JOB	ODOMETER READING					ANNUAL CHECK
			1000 km (600 mi)	10000 km (6000 mi)	20000 km (12000 mi)	30000 km (18000 mi)	40000 km (24000 mi)	
30	* Throttle grip housing and cable	<ul style="list-style-type: none"> <li>• Check operation and free play.</li> <li>• Adjust the throttle cable free play if necessary.</li> <li>• Lubricate the throttle grip housing and cable.</li> </ul>		√	√	√	√	√
31	* Lights, signals and switches	<ul style="list-style-type: none"> <li>• Check operation.</li> <li>• Adjust headlight beam.</li> </ul>	√	√	√	√	√	√

EAU72800

6

## TIP

- Air filter
  - This model's air filter is equipped with a disposable oil-coated paper element, which must not be cleaned with compressed air to avoid damaging it.
  - The air filter element needs to be replaced more frequently when riding in unusually wet or dusty areas.
- Hydraulic brake service
  - Regularly check and, if necessary, correct the brake fluid level.
  - Every two years replace the internal components of the brake master cylinders and calipers, and change the brake fluid.
  - Replace the brake hoses every four years and if cracked or damaged.



# Periodic maintenance and adjustment

## Checking the spark plugs

EAU19653

The spark plugs are important engine components, which should be checked periodically, preferably by a Yamaha dealer. Since heat and deposits will cause any spark plug to slowly erode, they should be removed and checked in accordance with the periodic maintenance and lubrication chart. In addition, the condition of the spark plugs can reveal the condition of the engine.

The porcelain insulator around the center electrode of each spark plug should be a medium-to-light tan (the ideal color when the vehicle is ridden normally), and all spark plugs installed in the engine should have the same color. If any spark plug shows a distinctly different color, the engine could be operating improperly. Do not attempt to diagnose such problems yourself. Instead, have a Yamaha dealer check the vehicle.

If a spark plug shows signs of electrode erosion and excessive carbon or other deposits, it should be replaced.

**Specified spark plug:**  
NGK/LMAR8A-9

Before installing a spark plug, the spark plug gap should be measured with a wire thickness gauge and, if necessary, adjusted to specification.

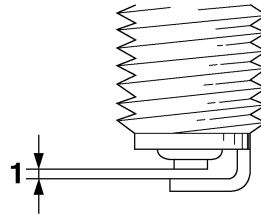

1. Spark plug gap

**Spark plug gap:**  
0.8–0.9 mm (0.031–0.035 in)

Clean the surface of the spark plug gasket and its mating surface, and then wipe off any grime from the spark plug threads.

**Tightening torque:**  
Spark plug:  
13 N·m (1.3 kgf·m, 9.6 lb·ft)

## TIP

If a torque wrench is not available when installing a spark plug, a good estimate of the correct torque is 1/4–1/2 turn past finger tight. However, the spark plug should be tightened to the specified torque as soon as possible.

ECA10841

## NOTICE

**Do not use any tools to remove or install the spark plug cap, otherwise the ignition coil coupler may get damaged. The spark plug cap may be difficult to remove because the rubber seal on the end of the cap fits tightly. To remove the spark plug cap, simply twist it back and forth while pulling it out; to install it, twist it back and forth while pushing it in.**

# Periodic maintenance and adjustment

## Canister

EAU36112

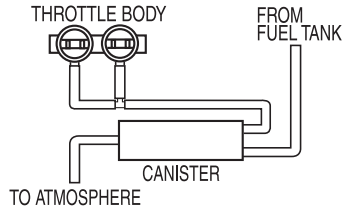

ZAUM1386

6

This model is equipped with a canister to prevent the discharging of fuel vapor into the atmosphere. Before operating this vehicle, make sure to check the following:

- Check each hose connection.
- Check each hose and canister for cracks or damage. Replace if damaged.
- Make sure that the canister breather is not blocked, and if necessary, clean it.

## Engine oil and oil filter cartridge

EAU60474

The engine oil level should be checked before each ride. In addition, the oil must be changed and the oil filter cartridge replaced at the intervals specified in the periodic maintenance and lubrication chart.

### To check the engine oil level

1. Place the vehicle on a level surface and hold it in an upright position. A slight tilt to the side can result in a false reading.
2. Start the engine, warm it up for several minutes, and then turn it off.
3. Wait a few minutes for the oil level to settle for an accurate reading, and then check the oil level through the engine oil level check window located at the bottom-left side of the crankcase.

### TIP

The engine oil should be between the minimum and maximum level marks.

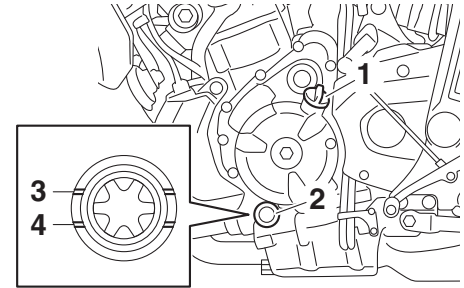

1. Engine oil filler cap
2. Engine oil level check window
3. Maximum level mark
4. Minimum level mark

4. If the engine oil is below the minimum level mark, add sufficient oil of the recommended type to raise it to the correct level.

### TIP

Check the O-ring for damage, and replace it if necessary.

# Periodic maintenance and adjustment

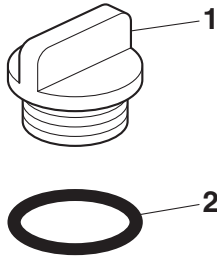

1. Engine oil filler cap
2. O-ring

## To change the engine oil (with or without oil filter cartridge replacement)

1. Place the vehicle on a level surface.
2. Start the engine, warm it up for several minutes, and then turn it off.
3. Place an oil pan under the engine to collect the used oil.
4. Remove the engine oil filler cap, the engine oil drain bolt and its gasket to drain the oil from the crankcase.

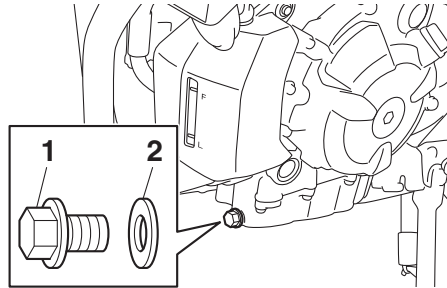

1. Engine oil drain bolt
2. Gasket

**TIP** Skip steps 5–7 if the oil filter cartridge is not being replaced.

5. Remove the oil filter cartridge with an oil filter wrench.

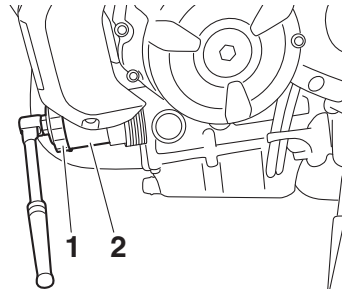

1. Oil filter wrench
2. Oil filter cartridge

**TIP** An oil filter wrench is available at a Yamaha dealer.

6. Apply a thin coat of clean engine oil to the O-ring of the new oil filter cartridge.

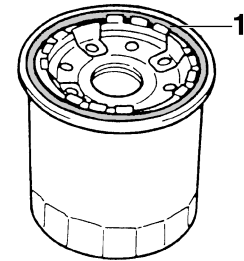

1. O-ring

**TIP** Make sure that the O-ring is properly seated.

7. Install the new oil filter cartridge with an oil filter wrench, and then tighten it to the specified torque with a torque wrench.

# Periodic maintenance and adjustment

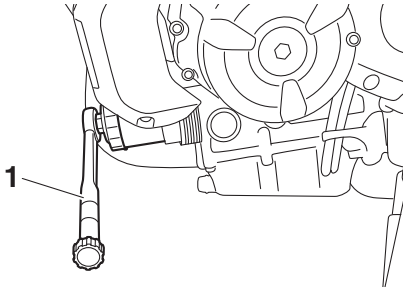

1. Torque wrench

6

## Tightening torque:

Oil filter cartridge:  
17 N·m (1.7 kgf·m, 13 lb·ft)

8. Install the engine oil drain bolt and its new gasket, and then tighten the bolt to the specified torque.

## Tightening torque:

Engine oil drain bolt:  
43 N·m (4.3 kgf·m, 32 lb·ft)

9. Refill with the specified amount of the recommended engine oil.

## Recommended engine oil:

See page 8-1.

## Oil quantity:

Without oil filter cartridge replacement:

2.30 L (2.43 US qt, 2.02 Imp.qt)

With oil filter cartridge replacement:

2.60 L (2.75 US qt, 2.29 Imp.qt)

## TIP

Be sure to wipe off spilled oil on any parts after the engine and exhaust system have cooled down.

ECA11621

## NOTICE

- In order to prevent clutch slippage (since the engine oil also lubricates the clutch), do not mix any chemical additives. Do not use oils with a diesel specification of “CD” or oils of a higher quality than specified. In addition, do not use oils labeled “ENERGY CONSERVING II” or higher.
- Make sure that no foreign material enters the crankcase.

10. Check the O-ring for damage, and replace it if necessary.

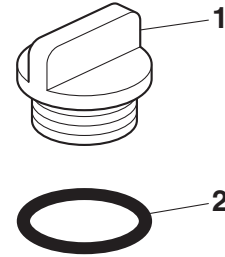

1. Engine oil filler cap
2. O-ring

11. Install and tighten the engine oil filler cap.
12. Start the engine, and then let it idle for several minutes while checking it for oil leakage. If oil is leaking, immediately turn the engine off and check for the cause.

## TIP

After the engine is started, the engine oil pressure warning light should go off.

ECA20860

## NOTICE

**If the oil pressure warning light flickers or remains on even if the oil level is correct, immediately turn the engine off and have a Yamaha dealer check the vehicle.**

13. Turn the engine off, wait a few minutes for the oil level to settle for an accurate reading, and then check the oil level and correct it if necessary.

## Why Yamalube

YAMALUBE oil is a Genuine YAMAHA Part born of the engineers' passion and belief that engine oil is an important liquid engine component. We form teams of specialists in the fields of mechanical engineering, chemistry, electronics and track testing, and have them develop the engine together with the oil it will use. Yamalube oils take full advantage of the base oil's qualities and blend in the ideal balance of additives to make sure the final oil clears our performance standards. Thus, Yamalube mineral, semisynthetic and synthetic oils have their own distinct characters and value. Yamaha's experience gained over many years of research and development into oil since the 1960's helps make Yamalube the best choice for your Yamaha engine.



EAU85450

## Coolant

The coolant level should be checked regularly. In addition, the coolant must be changed at the intervals specified in the periodic maintenance chart.

### Recommended coolant:

YAMALUBE coolant

### Coolant quantity:

Coolant reservoir (max level mark):  
0.25 L (0.26 US qt, 0.22 Imp.qt)  
Radiator (including all routes):  
1.60 L (1.69 US qt, 1.41 Imp.qt)

## TIP

If genuine Yamaha coolant is not available, use an ethylene glycol antifreeze containing corrosion inhibitors for aluminum engines and mix with distilled water at a 1:1 ratio.

EAU20097

## To check the coolant level

Since the coolant level varies with engine temperature, check when the engine is cold.

1. Park the vehicle on a level surface.

# Periodic maintenance and adjustment

2. With the vehicle in an upright position, look at the coolant level in the reservoir.

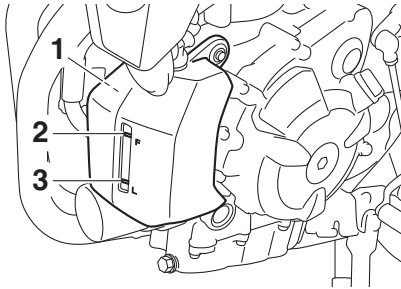

1. Coolant reservoir
2. Maximum level mark
3. Minimum level mark

3. If the coolant is at or below the minimum level mark, remove the coolant reservoir cap. **WARNING! Remove only the coolant reservoir cap. Never attempt to remove the radiator cap when the engine is hot.** [EWA15162]

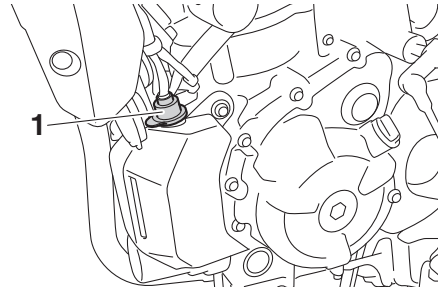

1. Coolant reservoir cap

4. Add coolant to the maximum level mark. **NOTICE: If coolant is not available, use distilled water or soft tap water instead. Do not use hard water or salt water since it is harmful to the engine. If water has been used instead of coolant, replace it with coolant as soon as possible, otherwise the cooling system will not be protected against frost and corrosion. If water has been added to the coolant, have a Yamaha dealer check the anti-freeze content of the coolant as soon as possible, otherwise the effectiveness of the coolant will be reduced.** [ECA10473]

5. Install the coolant reservoir cap.

EAU33032

## Changing the coolant

The coolant must be changed at the intervals specified in the periodic maintenance and lubrication chart. Have a Yamaha dealer change the coolant.

**WARNING! Never attempt to remove the radiator cap when the engine is hot.** [EWA10382]

# Periodic maintenance and adjustment

## Replacing the air filter element and cleaning the check hose

EAU60451

The air filter element should be replaced at the intervals specified in the periodic maintenance and lubrication chart. Have a Yamaha dealer replace the air filter element more frequently if you are riding in unusually wet or dusty areas. However, the air filter check hose can be easily reached and should be frequently checked and cleaned if necessary.

### To clean the air filter check hose

1. Remove the air filter check hose under the air filter case.

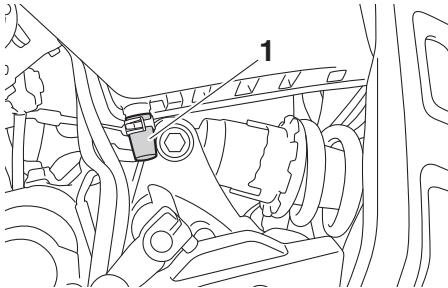

1. Air filter check hose

2. Clean and then install the hose.

## Checking the throttle grip free play

EAU21386

Measure the throttle grip free play as shown.

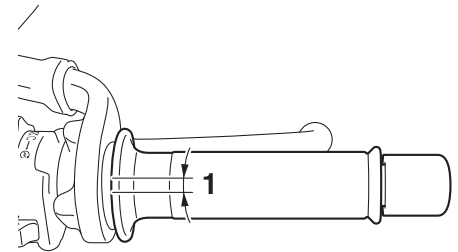

1. Throttle grip free play

**Throttle grip free play:**  
3.0–5.0 mm (0.12–0.20 in)

Periodically check the throttle grip free play and, if necessary, have a Yamaha dealer adjust it.

# Periodic maintenance and adjustment

6

## Valve clearance

EAU21403

The valves are an important engine component, and since valve clearance changes with use, they must be checked and adjusted at the intervals specified in the periodic maintenance chart. Unadjusted valves can result in improper air-fuel mixture, engine noise, and eventually engine damage. To prevent this from occurring, have your Yamaha dealer check and adjust the valve clearance at regular intervals.

### TIP

This service must be performed when the engine is cold.

## Tires

EAU64412

Tires are the only contact between the vehicle and the road. Safety in all conditions of riding depends on a relatively small area of road contact. Therefore, it is essential to maintain the tires in good condition at all times and replace them at the appropriate time with the specified tires.

### Tire air pressure

The tire air pressure should be checked and, if necessary, adjusted before each ride.

EWA10504



**Operation of this vehicle with improper tire pressure may cause severe injury or death from loss of control.**

- The tire air pressure must be checked and adjusted on cold tires (i.e., when the temperature of the tires equals the ambient temperature).
- The tire air pressure must be adjusted in accordance with the riding speed and with the total

**weight of rider, passenger, cargo, and accessories approved for this model.**

### Cold tire air pressure:

#### 1 person:

Front:

225 kPa (2.25 kgf/cm<sup>2</sup>, 33 psi)

Rear:

250 kPa (2.50 kgf/cm<sup>2</sup>, 36 psi)

#### 2 persons:

Front:

225 kPa (2.25 kgf/cm<sup>2</sup>, 33 psi)

Rear:

250 kPa (2.50 kgf/cm<sup>2</sup>, 36 psi)

### Maximum load:

Vehicle:

181 kg (399 lb)

The vehicle's maximum load is the combined weight of the rider, passenger, cargo, and any accessories.

EWA10512



**Never overload your vehicle. Operation of an overloaded vehicle could cause an accident.**



# Periodic maintenance and adjustment

## Tire inspection

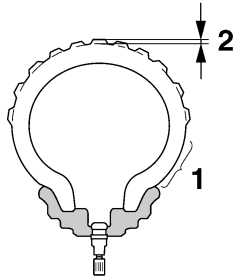

1. Tire sidewall
2. Tire tread depth

The tires must be checked before each ride. If the center tread depth reaches the specified limit, if the tire has a nail or glass fragments in it, or if the sidewall is cracked, have a Yamaha dealer replace the tire immediately.

**Minimum tire tread depth (front and rear):**  
1.6 mm (0.06 in)

## TIP

The tire tread depth limits may differ from country to country. Always comply with the local regulations.

## ⚠ WARNING

EWA10472

- Have a Yamaha dealer replace excessively worn tires. Besides being illegal, operating the vehicle with excessively worn tires decreases riding stability and can lead to loss of control.
- The replacement of all wheel and brake-related parts, including the tires, should be left to a Yamaha dealer, who has the necessary professional knowledge and experience to do so.
- Ride at moderate speeds after changing a tire since the tire surface must first be “broken in” for it to develop its optimal characteristics.

## Tire information

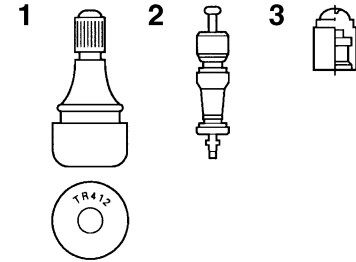

1. Tire air valve
2. Tire air valve core
3. Tire air valve cap with seal

This model is equipped with tubeless tires and tire air valves. Tires age, even if they have not been used or have only been used occasionally. Cracking of the tread and sidewall rubber, sometimes accompanied by carcass deformation, is an evidence of ageing. Old and aged tires shall be checked by tire specialists to ascertain their suitability for further use.

EWA10902

## ⚠ WARNING

- The front and rear tires should be of the same make and design, otherwise the handling

# Periodic maintenance and adjustment

characteristics of the motorcycle may be different, which could lead to an accident.

- Always make sure that the valve caps are securely installed to prevent air pressure leakage.
- Use only the tire valves and valve cores listed below to avoid tire deflation during a ride.

After extensive tests, only the tires listed below have been approved for this model by Yamaha.

## Front tire:

Size:

120/70 ZR 17 M/C (58W)

Manufacturer/model:

MICHELIN/PILOT ROAD 4

## Rear tire:

Size:

180/55 ZR 17 M/C (73W)

Manufacturer/model:

MICHELIN/PILOT ROAD 4 R TL

## FRONT and REAR:

Tire air valve:

TR412

Valve core:

#9100 (original)

EWA10601



This motorcycle is fitted with super-high-speed tires. Note the following points in order to make the most efficient use of these tires.

- Use only the specified replacement tires. Other tires may run the danger of bursting at super high speeds.
- Brand-new tires can have a relatively poor grip on certain road surfaces until they have been “broken in”. Therefore, it is advisable before doing any high-speed riding to ride conservatively for approximately 100 km (60 mi) after installing a new tire.
- The tires must be warmed up before a high-speed run.
- Always adjust the tire air pressure according to the operating conditions.

EAU21963

## Cast wheels

To maximize the performance, durability, and safe operation of your vehicle, note the following points regarding the specified wheels.

- The wheel rims should be checked for cracks, bends, warp-age or other damage before each ride. If any damage is found, have a Yamaha dealer replace the wheel. Do not attempt even the smallest repair to the wheel. A deformed or cracked wheel must be replaced.
- The wheel should be balanced whenever either the tire or wheel has been changed or replaced. An unbalanced wheel can result in poor performance, adverse handling characteristics, and a shortened tire life.

## Adjusting the clutch lever free play

EAU33893

Measure the clutch lever free play as shown.

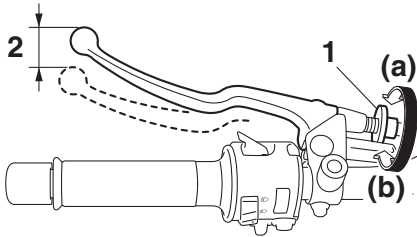

1. Clutch lever free play adjusting bolt
2. Clutch lever free play

**Clutch lever free play:**  
5.0–10.0 mm (0.20–0.39 in)

Periodically check the clutch lever free play and, if necessary, adjust it as follows.

To increase the clutch lever free play, turn the clutch lever free play adjusting bolt at the clutch lever in direction (a). To decrease the clutch lever free play, turn the adjusting bolt in direction (b).

**TIP** \_\_\_\_\_  
If the specified clutch lever free play cannot be obtained as described above, proceed as follows.

1. Fully turn the adjusting bolt at the clutch lever in direction (a) to loosen the clutch cable.
2. Loosen the locknut at the crankcase.

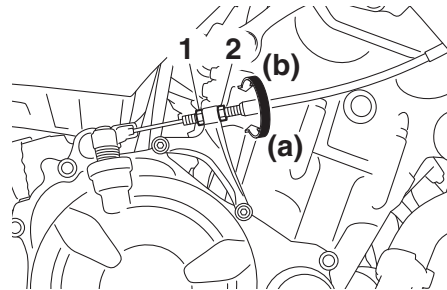

1. Locknut
2. Clutch lever free play adjusting nut
3. To increase the clutch lever free play, turn the clutch lever free play adjusting nut in direction (a). To decrease the clutch lever free play, turn the adjusting nut in direction (b).
4. Tighten the locknut.

## Checking the brake lever free play

EAU37914

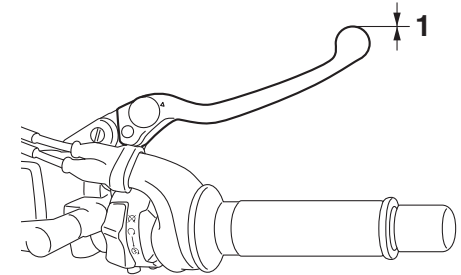

1. No brake lever free play

There should be no free play at the brake lever end. If there is free play, have a Yamaha dealer inspect the brake system.

EWA14212

### **⚠ WARNING**

**A soft or spongy feeling in the brake lever can indicate the presence of air in the hydraulic system. If there is air in the hydraulic system, have a Yamaha dealer bleed the system before operating the vehicle. Air in the hydraulic system will diminish the**

# Periodic maintenance and adjustment

braking performance, which may result in loss of control and an accident.

## Brake light switches

EAU36505

The brake light should come on just before braking takes effect. The brake light is activated by switches connected to the brake lever and brake pedal. Since the brake light switches are components of the anti-lock brake system, they should only be serviced by a Yamaha dealer.

## Checking the front and rear brake pads

EAU22393

The front and rear brake pads must be checked for wear at the intervals specified in the periodic maintenance and lubrication chart.

### Front brake pads

EAU36891

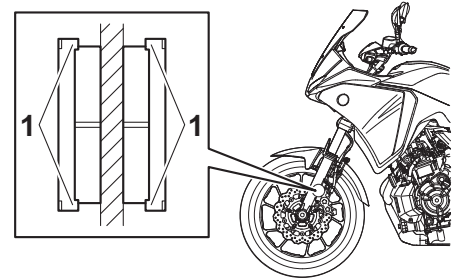

1. Brake pad wear indicator

Each front brake pad is provided with wear indicators, which allows you to check the brake pad wear without having to disassemble the brake. To check the brake pad wear, check the position of the wear indicators while applying the brake. If a brake pad has worn to the point that a wear indicator almost

# Periodic maintenance and adjustment

touches the brake disc, have a Yamaha dealer replace the brake pads as a set.

## Rear brake pads

EAU46292

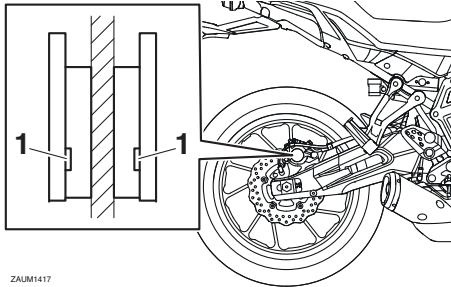

ZAJUM1417

1. Brake pad wear indicator groove

Each rear brake pad is provided with wear indicator grooves, which allow you to check the brake pad wear without having to disassemble the brake. To check the brake pad wear, check the wear indicator grooves. If a brake pad has worn to the point that a wear indicator groove almost appears, have a Yamaha dealer replace the brake pads as a set.

## Checking the brake fluid level

EAU40262

Before riding, check that the brake fluid is above the minimum level mark. Check the brake fluid level with the top of the reservoir level. Replenish the brake fluid if necessary.

## Front brake

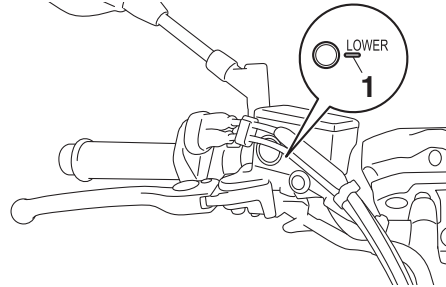

1. Minimum level mark

## Rear brake

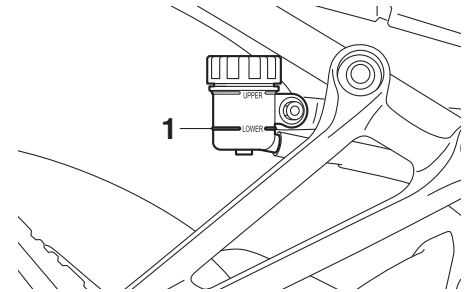

1. Minimum level mark

**Specified brake fluid:**  
DOT 4

6

EWA16011

## **⚠ WARNING**

**Improper maintenance can result in loss of braking ability. Observe these precautions:**

- **Insufficient brake fluid may allow air to enter the brake system, reducing braking performance.**
- **Clean the filler cap before removing. Use only DOT 4 brake fluid from a sealed container.**

# Periodic maintenance and adjustment

---

6

- **Use only the specified brake fluid; otherwise, the rubber seals may deteriorate, causing leakage.**
- **Refill with the same type of brake fluid. Adding a brake fluid other than DOT 4 may result in a harmful chemical reaction.**
- **Be careful that water or dust does not enter the brake fluid reservoir when refilling. Water will significantly lower the boiling point of the fluid and may result in vapor lock, and dirt may clog the ABS hydraulic unit valves.**

fluid level goes down suddenly, have a Yamaha dealer check the cause before further riding.

ECA17641

## **NOTICE**

**Brake fluid may damage painted surfaces or plastic parts. Always clean up spilled fluid immediately.**

As the brake pads wear, it is normal for the brake fluid level to gradually go down. A low brake fluid level may indicate worn brake pads and/or brake system leakage; therefore, be sure to check the brake pads for wear and the brake system for leakage. If the brake

EAU22734

## **Changing the brake fluid**

Have a Yamaha dealer change the brake fluid every 2 years. In addition, have the seals of the master cylinders and brake calipers, as well as the brake hoses replaced at the intervals listed below or sooner if they are damaged or leaking.

- Brake seals: every 2 years
- Brake hoses: every 4 years

## Drive chain slack

The drive chain slack should be checked before each ride and adjusted if necessary.

### To check the drive chain slack

1. Place the motorcycle on the side-stand.

### TIP

When checking and adjusting the drive chain slack, there should be no weight on the motorcycle.

2. Shift the transmission into the neutral position.
3. Push down on the drive chain under the end of the drive chain guard.
4. Measure distance A between the drive chain guard and the center of the chain as shown.

EAU22762

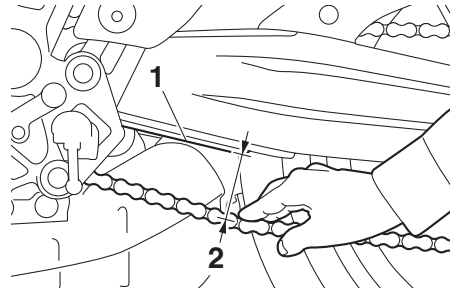

1. Drive chain guide
2. Distance A

#### Distance A:

30.0–35.0 mm (1.18–1.38 in)

5. If distance A is incorrect, adjust it as follows. **NOTICE: Improper drive chain slack will overload the engine as well as other vital parts of the motorcycle and can lead to chain slippage or breakage. If distance A is more than 40.0 mm (1.57 in), the chain can damage the frame, swingarm, and other parts. To prevent this from occurring, keep the drive chain slack within the specified limits.** [ECA23070]

## To adjust the drive chain slack

Consult a Yamaha dealer before adjusting the drive chain slack.

1. Loosen the axle nut and the locknut on each side of the swingarm.

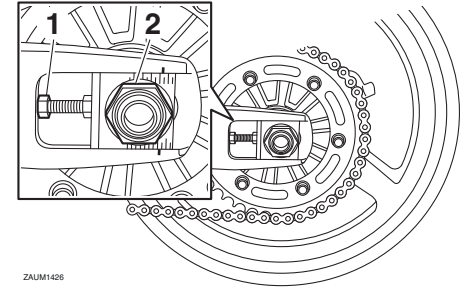

ZAUM1426

1. Locknut
  2. Axle nut
2. To tighten the drive chain, turn the drive chain slack adjusting bolt on each side of the swingarm in direction (a). To loosen the drive chain, turn the adjusting bolt on each side of the swingarm in direction (b), and then push the rear wheel forward.

# Periodic maintenance and adjustment

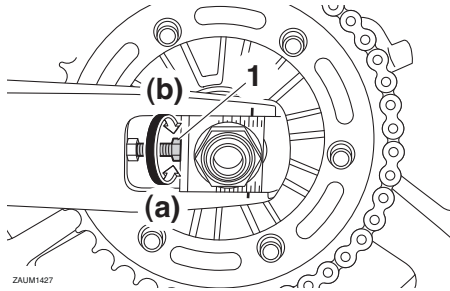

1. Drive chain slack adjusting bolt

6

## TIP

Using the alignment marks on each side of the swingarm, make sure that both drive chain pullers are in the same position for proper wheel alignment.

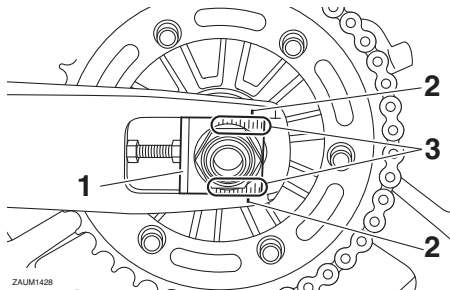

1. Drive chain puller
2. Notch
3. Alignment marks

3. Tighten the axle nut, then the locknuts to their specified torques.

### Tightening torques:

Axle nut:

150 N·m (15 kgf·m, 108 lb·ft)

Locknut:

16 N·m (1.6 kgf·m, 12 lb·ft)

4. Make sure that the drive chain pullers are in the same position, the drive chain slack is correct, and the drive chain moves smoothly.

## Cleaning and lubricating the drive chain

The drive chain must be cleaned and lubricated at the intervals specified in the periodic maintenance and lubrication chart, otherwise it will quickly wear out, especially when riding in dusty or wet areas. Service the drive chain as follows.

### NOTICE

**The drive chain must be lubricated after washing the motorcycle, riding in the rain or riding in wet areas.**

1. Clean the drive chain with kerosene and a small soft brush.  
**NOTICE:** To prevent damaging the O-rings, do not clean the drive chain with steam cleaners, high-pressure washers or inappropriate solvents. [ECA11122]
2. Wipe the drive chain dry.
3. Thoroughly lubricate the drive chain with a special O-ring chain lubricant. **NOTICE:** Do not use engine oil or any other lubricants for the drive chain, as they



may contain substances that could damage the O-rings.

[ECA11112]

## Checking and lubricating the cables

EAU23098

The operation of all control cables and the condition of the cables should be checked before each ride, and the cables and cable ends should be lubricated if necessary. If a cable is damaged or does not move smoothly, have a Yamaha dealer check or replace it. **WARNING! Damage to the outer housing of cables may result in internal rusting and cause interference with cable movement. Replace damaged cables as soon as possible to prevent unsafe conditions.** [EWA10712]

### Recommended lubricant:

Yamaha cable lubricant or other suitable cable lubricant

## Checking and lubricating the throttle grip and cable

EAU23115

The operation of the throttle grip should be checked before each ride. In addition, the cable should be lubricated by a Yamaha dealer at the intervals specified in the periodic maintenance chart.

The throttle cable is equipped with a rubber cover. Make sure that the cover is securely installed. Even though the cover is installed correctly, it does not completely protect the cable from water entry. Therefore, use care not to pour water directly onto the cover or cable when washing the vehicle. If the cable or cover becomes dirty, wipe clean with a moist cloth.

# Periodic maintenance and adjustment

## Checking and lubricating the brake and shift pedals EAU44276

The operation of the brake and shift pedals should be checked before each ride, and the pedal pivots should be lubricated if necessary.

### Brake pedal

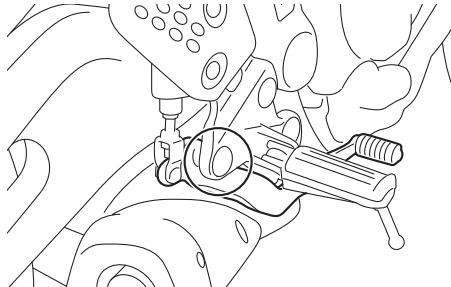

### Shift pedal

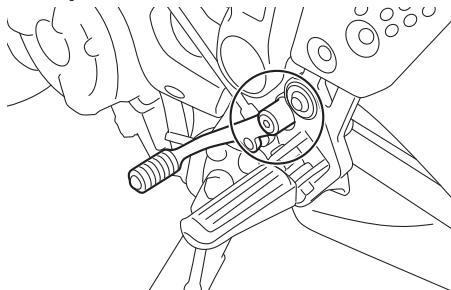

**Recommended lubricant:**  
Lithium-soap-based grease

## Checking and lubricating the brake and clutch levers EAU23144

The operation of the brake and clutch levers should be checked before each ride, and the lever pivots should be lubricated if necessary.

### Brake lever

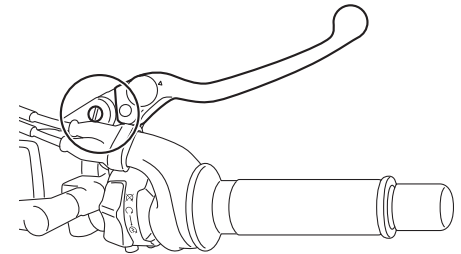

### Clutch lever

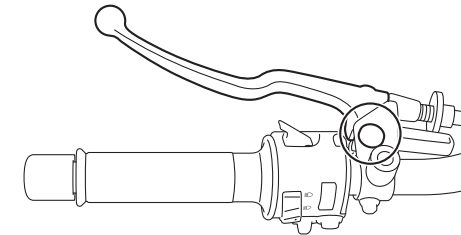

# Periodic maintenance and adjustment

## Recommended lubricants:

- Brake lever:
  - Silicone grease
- Clutch lever:
  - Lithium-soap-based grease

## Checking and lubricating the sidestand

EAU23203

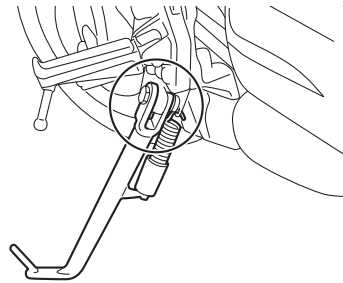

The operation of the sidestand should be checked before each ride, and the sidestand pivot and metal-to-metal contact surfaces should be lubricated if necessary.

EWA10732

### **⚠ WARNING**

**If the sidestand does not move up and down smoothly, have a Yamaha dealer check or repair it. Otherwise, the sidestand could contact the ground and distract the operator, resulting in a possible loss of control.**

**Recommended lubricant:**  
Lithium-soap-based grease

## Lubricating the rear suspension

EAU23252

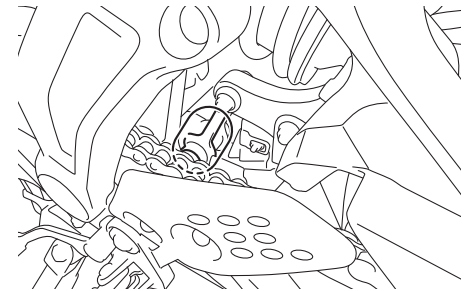

The pivoting points of the rear suspension must be lubricated by a Yamaha dealer at the intervals specified in the periodic maintenance and lubrication chart.

**Recommended lubricant:**  
Lithium-soap-based grease

# Periodic maintenance and adjustment

## Lubricating the swingarm pivots

EAUM1653

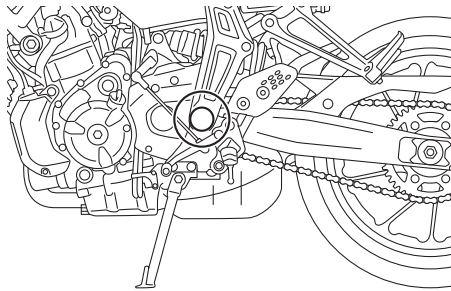

The swingarm pivots must be lubricated by a Yamaha dealer at the intervals specified in the periodic maintenance and lubrication chart.

**Recommended lubricant:**  
Lithium-soap-based grease

## Checking the front fork

EAU23273

The condition and operation of the front fork must be checked as follows at the intervals specified in the periodic maintenance and lubrication chart.

### To check the condition

Check the inner tubes for scratches, damage and excessive oil leakage.

### To check the operation

1. Place the vehicle on a level surface and hold it in an upright position. **WARNING! To avoid injury, securely support the vehicle so there is no danger of it falling over.** [EWA10752]
2. While applying the front brake, push down hard on the handlebars several times to check if the front fork compresses and rebounds smoothly.

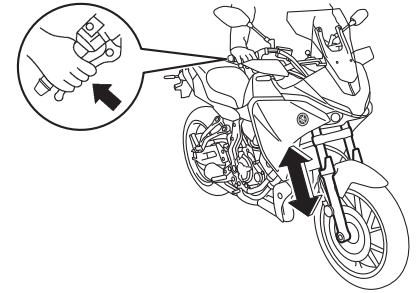

ECA10591

### **NOTICE**

**If any damage is found or the front fork does not operate smoothly, have a Yamaha dealer check or repair it.**

## Checking the steering

EAU23285

Worn or loose steering bearings may cause danger. Therefore, the operation of the steering must be checked as follows at the intervals specified in the periodic maintenance and lubrication chart.

1. Raise the front wheel off the ground. (See page 6-33.)  
**WARNING! To avoid injury, securely support the vehicle so there is no danger of it falling over.** [EWA10752]
2. Hold the lower ends of the front fork legs and try to move them forward and backward. If any free play can be felt, have a Yamaha dealer check or repair the steering.

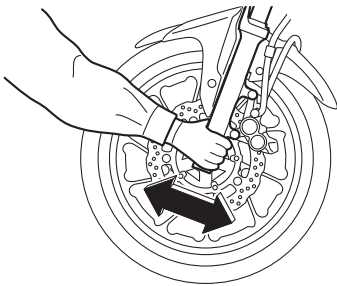

## Checking the wheel bearings

EAU23292

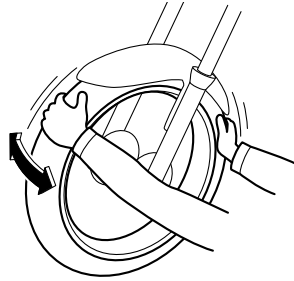

The front and rear wheel bearings must be checked at the intervals specified in the periodic maintenance and lubrication chart. If there is play in the wheel hub or if the wheel does not turn smoothly, have a Yamaha dealer check the wheel bearings.

## Battery

EAU50292

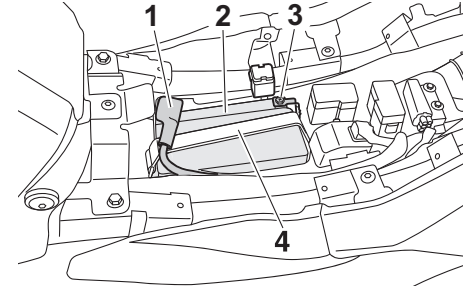

1. Positive battery lead (red)
2. Battery
3. Negative battery lead (black)
4. Battery band

The battery is located under the seat. (See page 3-19.)

This model is equipped with a VRLA (Valve Regulated Lead Acid) battery. There is no need to check the electrolyte or to add distilled water. However, the battery lead connections need to be checked and, if necessary, tightened.

# Periodic maintenance and adjustment

6

## WARNING

EWA10761

- Electrolyte is poisonous and dangerous since it contains sulfuric acid, which causes severe burns. Avoid any contact with skin, eyes or clothing and always shield your eyes when working near batteries. In case of contact, administer the following FIRST AID.
  - **EXTERNAL:** Flush with plenty of water.
  - **INTERNAL:** Drink large quantities of water or milk and immediately call a physician.
  - **EYES:** Flush with water for 15 minutes and seek prompt medical attention.
- Batteries produce explosive hydrogen gas. Therefore, keep sparks, flames, cigarettes, etc., away from the battery and provide sufficient ventilation when charging it in an enclosed space.

- **KEEP THIS AND ALL BATTERIES OUT OF THE REACH OF CHILDREN.**

### To charge the battery

Have a Yamaha dealer charge the battery as soon as possible if it seems to have discharged. Keep in mind that the battery tends to discharge more quickly if the vehicle is equipped with optional electrical accessories.

ECA16522

### NOTICE

**To charge a VRLA (Valve Regulated Lead Acid) battery, a special (constant-voltage) battery charger is required. Using a conventional battery charger will damage the battery.**

### To store the battery

1. If the vehicle will not be used for more than one month, remove the battery, fully charge it, and then place it in a cool, dry place.  
**NOTICE: When removing the battery, be sure to turn the main**

**switch off, then disconnect the negative lead before disconnecting the positive lead.** [ECA16304]

2. If the battery will be stored for more than two months, check it at least once a month and fully charge it if necessary.
3. Fully charge the battery before installation. **NOTICE: When installing the battery, be sure to turn the main switch off, then connect the positive lead before connecting the negative lead.** [ECA16842]
4. After installation, make sure that the battery leads are properly connected to the battery terminals.

ECA16531

### NOTICE

**Always keep the battery charged. Storing a discharged battery can cause permanent battery damage.**

# Periodic maintenance and adjustment

EAU47175

## Replacing the fuses

The main fuse and the fuse boxes, which contain the fuses for the individual circuits, are located under the seat. (See page 3-19.)

### TIP

To access the main fuse, remove the starter relay cover as shown.

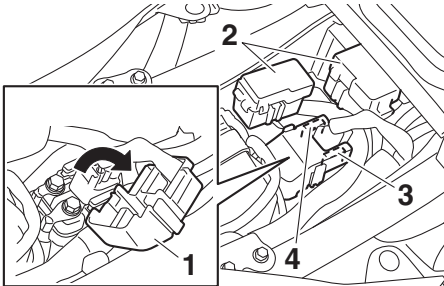

1. Starter relay cover
2. Fuse box
3. Spare main fuse
4. Main fuse

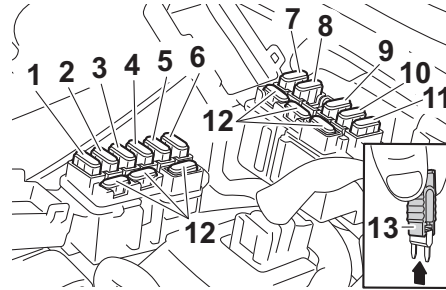

1. Ignition fuse
2. Signaling system fuse
3. Headlight fuse
4. Fuel injection system fuse
5. Backup fuse (for clock and immobilizer system)
6. Radiator fan motor fuse
7. ABS solenoid fuse
8. ABS motor fuse
9. Auxiliary fuse
10. ABS control unit fuse
11. Accessory fuse
12. Spare fuse
13. Fuse tweezers

If a fuse is blown, replace it as follows.

1. Turn the key to "OFF" and turn off the electrical circuit in question.
2. Remove the blown fuse, and then install a new fuse of the specified amperage. **WARNING! Do not**

use a fuse of a higher amperage rating than recommended to avoid causing extensive damage to the electrical system and possibly a fire. [EWA15132]

### Specified fuses:

- Main fuse: 30.0 A
- Accessory fuse: 10.0 A
- Auxiliary fuse: 3.0 A
- Headlight fuse: 7.5 A
- Signaling system fuse: 10.0 A
- Ignition fuse: 10.0 A
- Radiator fan motor fuse: 10.0 A
- Fuel injection system fuse: 10.0 A
- Backup fuse: 7.5 A
- ABS motor fuse: 30.0 A
- ABS control unit fuse: 7.5 A
- ABS solenoid fuse: 20.0 A

# Periodic maintenance and adjustment

3. Turn the key to “ON” and turn on the electrical circuit in question to check if the device operates.
4. If the fuse immediately blows again, have a Yamaha dealer check the electrical system.

## Vehicle lights

EAU80380

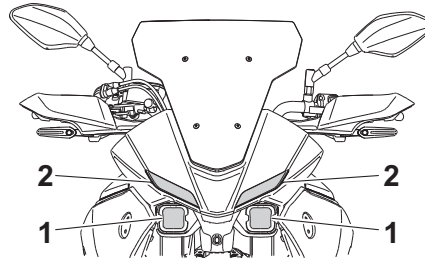

1. Headlight
2. Auxiliary light

Except for the license plate light bulb, this model's lights are all LED. If an LED light does not come on, check the fuses and then have a Yamaha dealer check the vehicle. If the license plate light does not come on, check and replace the bulb. (See page 6-32.)

ECA16581

### **NOTICE**

**Do not affix any type of tinted film or stickers to the headlight lens.**

## Replacing the license plate light bulb

EAU59890

1. Remove the license plate light unit by removing the nuts, washers and collars, and then remove the license plate light bulb socket (together with the bulb) by pulling it out.

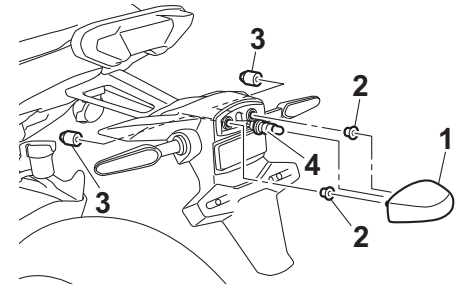

1. License plate light unit
2. Collar
3. Nut
4. License plate light bulb socket

2. Remove the burnt-out bulb by pulling it out.



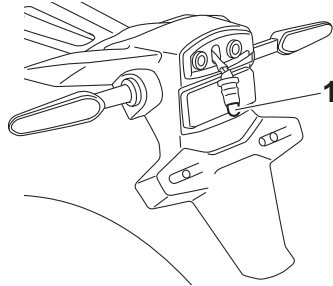

1. License plate light bulb

3. Insert a new bulb into the socket.
4. Install the socket (together with the bulb) by pushing it in, and then install the license plate light unit by installing the collars, washers and nuts.

## Supporting the motorcycle

EAU67131

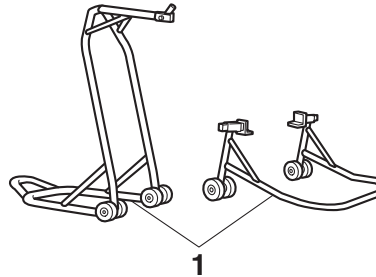

1. Maintenance stand (example)

Since this model is not equipped with a centerstand, use maintenance stands when removing the front or rear wheel or when performing other maintenance that requires the motorcycle to stand up right.

Check that the motorcycle is in a stable and level position before starting any maintenance.

## Troubleshooting

EAU25872

Although Yamaha motorcycles receive a thorough inspection before shipment from the factory, trouble may occur during operation. Any problem in the fuel, compression, or ignition systems, for example, can cause poor starting and loss of power.

The following troubleshooting charts represent quick and easy procedures for checking these vital systems yourself. However, should your motorcycle require any repair, take it to a Yamaha dealer, whose skilled technicians have the necessary tools, experience, and know-how to service the motorcycle properly.

Use only genuine Yamaha replacement parts. Imitation parts may look like Yamaha parts, but they are often inferior, have a shorter service life and can lead to expensive repair bills.

EWA15142

### **WARNING**

**When checking the fuel system, do not smoke, and make sure there are no open flames or sparks in the area, including pilot lights from water**

## **Periodic maintenance and adjustment**

---

heaters or furnaces. Gasoline or gasoline vapors can ignite or explode, causing severe injury or property damage.

---

## Troubleshooting chart

### 1. Fuel

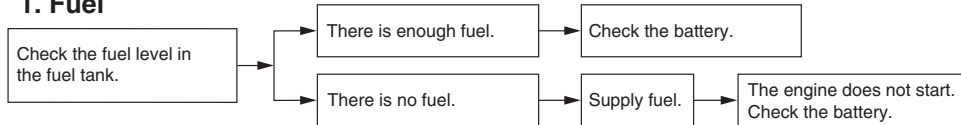

### 2. Battery

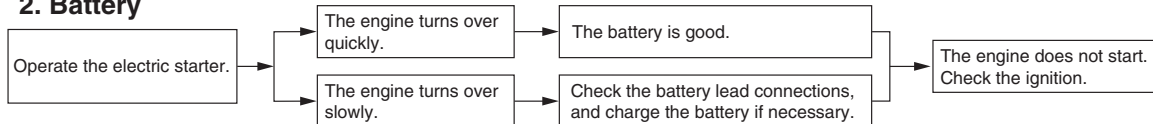

### 3. Ignition

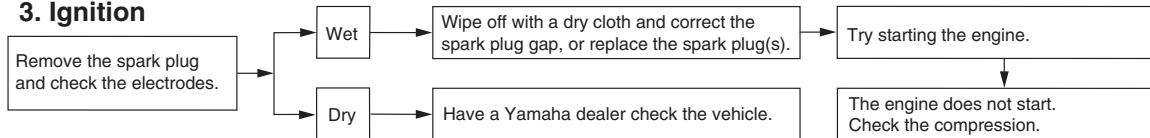

### 4. Compression

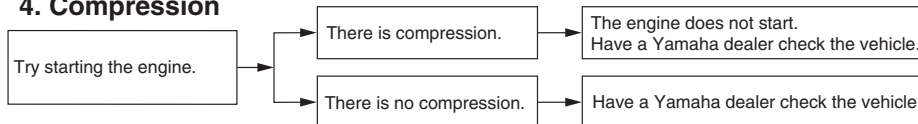

# Periodic maintenance and adjustment

EAU86420

## Engine overheating

EWAT1041

### **⚠ WARNING**

- Do not remove the radiator cap when the engine and radiator are hot. Scalding hot fluid and steam may be blown out under pressure, which could cause serious injury. Be sure to wait until the engine has cooled.
- Place a thick rag, like a towel, over the radiator cap, and then slowly rotate the cap counterclockwise to the detent to allow any residual pressure to escape. When the hissing sound has stopped, press down on the cap while turning it counterclockwise, and then remove the cap.

6

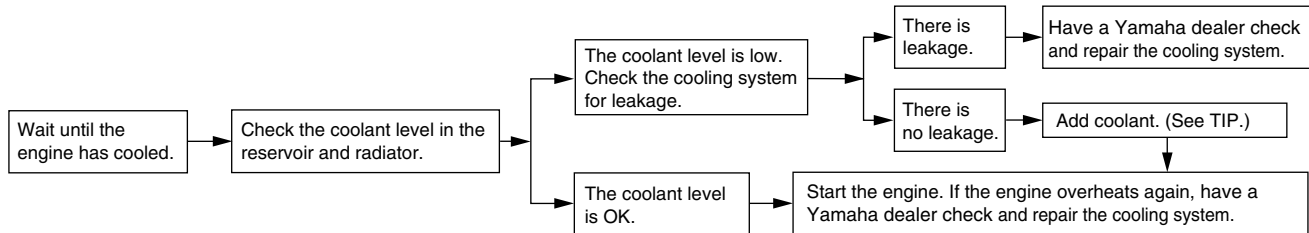

### **TIP**

If coolant is not available, tap water can be temporarily used instead, provided that it is changed to the recommended coolant as soon as possible.

## Matte color caution

EAU37834

ECA15193

### NOTICE

Some models are equipped with matte colored finished parts. Be sure to consult a Yamaha dealer for advice on what products to use before cleaning the vehicle. Using a brush, harsh chemical products or cleaning compounds when cleaning these parts will scratch or damage their surface. Wax also should not be applied to any matte colored finished parts.

## Care

EAU83443

Frequent, thorough cleaning of the vehicle will not only enhance its appearance but also will improve its general performance and extend the useful life of many components. Washing, cleaning, and polishing will also give you a chance to inspect the condition of the vehicle more frequently. Be sure to wash the vehicle after riding in the rain or near the sea, because salt is corrosive to metals.

### TIP

- The roads of heavy snowfall areas may be sprayed with salt as a de-icing method. This salt can stay on the roads well into spring, so be sure to wash the underside and chassis parts after riding in such areas.
- Genuine Yamaha care and maintenance products are sold under the YAMALUBE brand in many markets worldwide.
- See your Yamaha dealer for additional cleaning tips.

ECA26280

### NOTICE

Improper cleaning can cause cosmetic and mechanical damage. Do not use:

- high-pressure washers or steam-jet cleaners. Excessive water pressure may cause water seepage and deterioration of wheel bearings, brakes, transmission seals and electrical devices. Avoid high-pressure detergent applications such as those available in coin-operated car washers.
- harsh chemicals, including strong acidic wheel cleaners, especially on spoke or magnesium wheels.
- harsh chemicals, abrasive cleaning compounds, or wax on matte-finished parts. Brushes can scratch and damage the matte-finish, use soft sponge or towel only.
- towels, sponges, or brushes contaminated with abrasive cleaning products or strong

# Motorcycle care and storage

---

chemicals such as, solvents, gasoline, rust removers, brake fluid, or antifreeze, etc.

---

## Before washing

1. Park the vehicle out of direct sunlight and allow it to cool. This will help avoid water spots.
2. Make sure all caps, covers, electrical couplers and connectors are tightly installed.
3. Cover the muffler end with a plastic bag and a strong rubber band.
4. Pre-soak stubborn stains like insects or bird droppings with a wet towel for a few minutes.
5. Remove road grime and oil stains with a quality degreasing agent and a plastic-bristle brush or sponge. **NOTICE: Do not use degreasing agent on areas requiring lubrication such as seals, gaskets, and wheel axles. Follow product instructions.**

[ECA26290]

## Washing

1. Rinse off any degreaser and spray down the vehicle with a garden hose. Use only enough pressure to do the job. Avoid spraying water directly into the muffler, instrument panel, air inlet, or other inner areas such as underseat storage compartments.
2. Wash the vehicle with a quality automotive-type detergent mixed with cool water and a soft, clean towel or sponge. Use an old toothbrush or plastic-bristle brush for hard-to-reach places. **NOTICE: Use cold water if the vehicle has been exposed to salt. Warm water will increase salt's corrosive properties.** [ECA26301]
3. For windshield-equipped vehicles: Clean the windshield with a soft towel or sponge dampened with water and a pH neutral detergent. If necessary, use a high-quality windshield cleaner or polish for motorcycles. **NOTICE: Never use any strong chemicals to clean the windshield. Additionally, some cleaning compounds for**

**plastic may scratch the windshield, so be sure to test all cleaning products before general application.** [ECA26310]

4. Rinse off thoroughly with clean water. Be sure to remove all detergent residues, as they can be harmful to plastic parts.

## After washing

1. Dry the vehicle with a chamois or absorbent towel, preferably microfiber terrycloth.
2. For drive chain-equipped models: Dry and then lubricate the drive chain to prevent rust.
3. Use a chrome polish to shine chrome, aluminum, and stainless steel parts. Often the thermally induced discoloring of stainless steel exhaust systems can be removed through polishing.
4. Apply a corrosion protection spray on all metal parts including chrome or nickel-plated surfaces. **WARNING! Do not apply silicone or oil spray to seats, hand grips, rubber foot pegs or tire treads. Otherwise these parts**

will become slippery, which could cause loss of control. Thoroughly clean the surfaces of these parts before operating the vehicle. [EWA20650]

5. Treat rubber, vinyl, and unpainted plastic parts with a suitable care product.
6. Touch up minor paint damage caused by stones, etc.
7. Wax all painted surfaces using a non-abrasive wax or use a detail spray for motorcycles.
8. When finished cleaning, start the engine and let it idle for several minutes to help dry any remaining moisture.
9. If the headlight lens has fogged up, start the engine and turn on the headlight to help remove the moisture.
10. Let the vehicle dry completely before storing or covering it.

ECA26320

## NOTICE

- Do not apply wax to rubber or unpainted plastic parts.

- Do not use abrasive polishing compounds as they will wear away the paint.
- Apply sprays and wax sparingly. Wipe off excess afterwards.

EWA20660

## ⚠ WARNING

**Contaminants left on the brakes or tires can cause loss of control.**

- Make sure there is no lubricant or wax on the brakes or tires.
- If necessary, wash the tires with warm water and a mild detergent.
- If necessary, clean the brake discs and pads with brake cleaner or acetone.
- Before riding at higher speeds, test the vehicle's braking performance and cornering behavior.

## Storage

Always store the vehicle in a cool, dry place. If necessary, protect it against dust with a porous cover. Be sure the engine and the exhaust system are cool before covering the vehicle. If the vehicle often sits for weeks at a time between uses, the use of a quality fuel stabilizer is recommended after each fill-up.

ECA21170

## NOTICE

- Storing the vehicle in a poorly ventilated room or covering it with a tarp, while it is still wet, will allow water and humidity to seep in and cause rust.
- To prevent corrosion, avoid damp cellars, stables (because of the presence of ammonia) and areas where strong chemicals are stored.

## Long term storage

Before storing the vehicle long term (60 days or more):

# Motorcycle care and storage

---

7

1. Make all necessary repairs and perform any outstanding maintenance.
2. Follow all instructions in the Care section of this chapter.
3. Fill up the fuel tank, adding fuel stabilizer according to product instructions. Run the engine for 5 minutes to distribute treated fuel through the fuel system.
4. For vehicles equipped with a fuel cock: Turn the fuel cock lever to the off position.
5. For vehicles with a carburetor: To prevent fuel deposits from building up, drain the fuel in the carburetor float chamber into a clean container. Retighten the drain bolt and pour the fuel back into the fuel tank.
6. Use a quality engine fogging oil according to product instructions to protect internal engine components from corrosion. If engine fogging oil is not available, perform the following steps for each cylinder:
  - a. Remove the spark plug cap and spark plug.
  - b. Pour a teaspoonful of engine oil into the spark plug bore.
  - c. Install the spark plug cap onto the spark plug, and then place the spark plug on the cylinder head so that the electrodes are grounded. (This will limit sparking during the next step.)
  - d. Turn the engine over several times with the starter. (This will coat the cylinder wall with oil.)  
**WARNING! To prevent damage or injury from sparking, make sure to ground the spark plug electrodes while turning the engine over.**  
[EWA10952]
  - e. Remove the spark plug cap from the spark plug, and then install the spark plug and the spark plug cap.
7. Lubricate all control cables, pivots, levers and pedals, as well as the sidestand and centerstand (if equipped).
8. Check and correct the tire air pressure, and then lift the vehicle so that all wheels are off the ground. Otherwise, turn the

wheels a little once a month in order to prevent the tires from becoming degraded in one spot.

9. Cover the muffler outlet with a plastic bag to prevent moisture from entering it.
10. Remove the battery and fully charge it, or attach a maintenance charger to keep the battery optimally charged. **NOTICE: Confirm that the battery and its charger are compatible. Do not charge a VRLA battery with a conventional charger.**[ECA26330]

---

## TIP

- If the battery will be removed, charge it once a month and store it in a temperate location between 0-30 °C (32-90 °F).
  - See page 6-29 for more information on charging and storing the battery.
-



## Dimensions:

- Overall length:  
2140 mm (84.3 in)
- Overall width:  
835 mm (32.9 in)
- Overall height:  
1290/1330 mm (50.8/52.4 in)
- Seat height:  
835 mm (32.9 in)
- Wheelbase:  
1460 mm (57.5 in)
- Ground clearance:  
140 mm (5.51 in)
- Minimum turning radius:  
2.7 m (8.86 ft)

## Weight:

- Curb weight:  
196 kg (432 lb)

## Engine:

- Engine type:  
Liquid cooled 4-stroke, DOHC
- Cylinder arrangement:  
Inline 2-cylinder
- Displacement:  
689 cm<sup>3</sup>
- Bore × stroke:  
80.0 × 68.6 mm (3.15 × 2.70 in)
- Starting system:  
Electric starter

## Engine oil:

Recommended brand:



SAE viscosity grades:  
10W-40

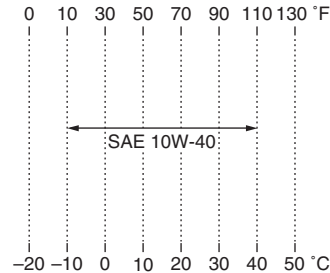

Recommended engine oil grade:  
API service SG type or higher, JASO  
standard MA

Engine oil quantity:

- Without oil filter cartridge replacement:  
2.30 L (2.43 US qt, 2.02 Imp.qt)
- With oil filter cartridge replacement:  
2.60 L (2.75 US qt, 2.29 Imp.qt)

## Coolant quantity:

- Coolant reservoir (up to the maximum level  
mark):  
0.25 L (0.26 US qt, 0.22 Imp.qt)
- Radiator (including all routes):  
1.60 L (1.69 US qt, 1.41 Imp.qt)

## Fuel:

- Recommended fuel:  
Unleaded gasoline (E10 acceptable)
- Octane number (RON):  
95
- Fuel tank capacity:  
17.0 L (4.49 US gal, 3.74 Imp.gal)
- Fuel reserve amount:  
3.5 L (0.92 US gal, 0.77 Imp.gal)

## Fuel injection:

- Throttle body:  
ID mark:  
1WS1 10

## Drivetrain:

- Gear ratio:  
1st:  
2.846 (37/13)
- 2nd:  
2.125 (34/16)
- 3rd:  
1.632 (31/19)
- 4th:  
1.300 (26/20)
- 5th:  
1.091 (24/22)
- 6th:  
0.964 (27/28)

## Front tire:

- Type:  
Tubeless
- Size:  
120/70 ZR 17 M/C (58W)
- Manufacturer/model:  
MICHELIN/PILOT ROAD 4

# Specifications

---

## Rear tire:

Type:

Tubeless

Size:

180/55 ZR 17 M/C (73W)

Manufacturer/model:

MICHELIN/PILOT ROAD 4 R TL

## Loading:

Maximum load:

181 kg (399 lb)

(Total weight of rider, passenger, cargo and accessories)

## Front brake:

Type:

Hydraulic dual disc brake

## Rear brake:

Type:

Hydraulic single disc brake

## Front suspension:

Type:

Telescopic fork

## Rear suspension:

Type:

Swingarm (link suspension)

## Electrical system:

System voltage:

12 V

## Battery:

Model:

YTZ7S

Voltage, capacity:

12 V, 6.3 Ah (20 HR)

## Bulb wattage:

Headlight:

LED

Brake/tail light:

LED

Front turn signal light:

LED

Rear turn signal light:

LED

Auxiliary light:

LED

License plate light:

5.0 W × 1

## Identification numbers

EAU53562

Record the vehicle identification number, engine serial number, and the model label information in the spaces provided below. These identification numbers are needed when registering the vehicle with the authorities in your area and when ordering spare parts from a Yamaha dealer.

VEHICLE IDENTIFICATION NUMBER:

ENGINE SERIAL NUMBER:

MODEL LABEL INFORMATION:

## Vehicle identification number

EAU26401

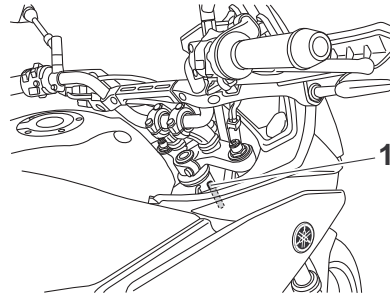

1. Vehicle identification number

The vehicle identification number is stamped into the steering head pipe. Record this number in the space provided.

### TIP

The vehicle identification number is used to identify your motorcycle and may be used to register your motorcycle with the licensing authority in your area.

## Engine serial number

EAU26442

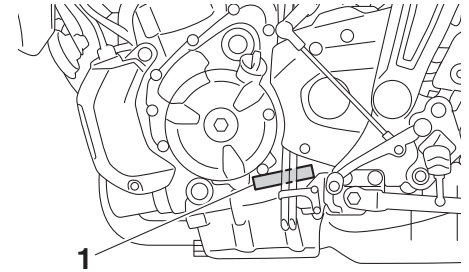

1. Engine serial number

The engine serial number is stamped into the crankcase.

## Model label

EAU26521

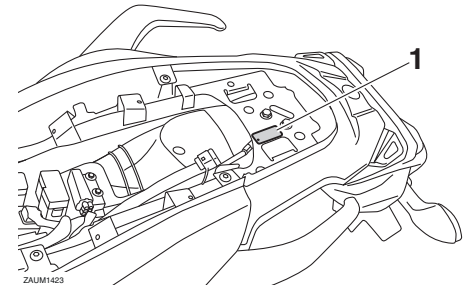

1. Model label

# Consumer information

The model label is affixed to the frame under the passenger seat. Record the information on this label in the space provided. This information will be needed when ordering spare parts from a Yamaha dealer.

## Diagnostic connector

EAU69910

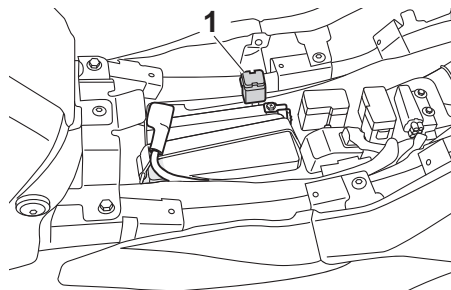

1. Diagnostic connector

The diagnostic connector is located as shown.

## Vehicle data recording

EAU85300

This model's ECU stores certain vehicle data to assist in the diagnosis of malfunctions and for research, statistical analysis and development purposes.

Although the sensors and recorded data will vary by model, the main data points are:

- Vehicle status and engine performance data
- Fuel-injection and emission-related data

This data will be uploaded only when a special Yamaha diagnostic tool is attached to the vehicle, such as when maintenance checks or service procedures are performed.

Vehicle data uploaded will be handled appropriately according to the following Privacy Policy.

### Privacy Policy

<https://www.yamaha-motor.eu/eu/privacy/privacy-policy.aspx>

Yamaha will not disclose this data to a third party except in the following cases. In addition, Yamaha may provide vehicle data to a contractor in order to outsource services related to the handling of vehicle data. Even in this case, Yamaha will require the contractor to properly handle the vehicle data we provided and Yamaha will appropriately manage the data.

- With the consent of the vehicle owner
- Where obligated by law
- For use by Yamaha in litigation
- When the data is not related to an individual vehicle nor owner

# Index

## A

- ABS .....3-14
- ABS warning light .....3-5
- Air filter element and check hose,  
replacing and cleaning .....6-15
- Auxiliary DC connector .....3-24

## B

- Battery .....6-29
- Brake and clutch levers, checking and  
lubricating .....6-26
- Brake and shift pedals, checking and  
lubricating .....6-26
- Brake fluid, changing .....6-22
- Brake fluid level, checking .....6-21
- Brake lever .....3-14
- Brake lever free play, checking .....6-19
- Brake light switches .....6-20
- Brake pedal .....3-14

## C

- Cables, checking and lubricating .....6-25
- Canister .....6-10
- Care .....7-1
- Catalytic converter .....3-18
- Clutch lever .....3-13
- Clutch lever free play, adjusting .....6-19
- Coolant .....6-13
- Coolant temperature warning light .....3-4

## D

- Data recording, vehicle .....9-2
- Diagnostic connector .....9-2
- Dimmer switch .....3-12
- Drive chain, cleaning and lubricating ... 6-24
- Drive chain slack .....6-23

## E

- Engine break-in ..... 5-1
- Engine oil and oil filter cartridge ..... 6-10
- Engine overheating ..... 6-36
- Engine serial number ..... 9-1

## F

- Front and rear brake pads, checking ... 6-20
- Front fork, adjusting ..... 3-21
- Front fork, checking ..... 6-28
- Fuel .....3-16
- Fuel consumption, tips for reducing ..... 5-4
- Fuel tank breather hose and overflow  
hose ..... 3-18
- Fuel tank cap ..... 3-15
- Fuses, replacing ..... 6-31

## H

- Handlebar switches ..... 3-12
- Hazard lights switch ..... 3-12
- Helmet holding cable ..... 3-19
- High beam indicator light ..... 3-3
- Horn switch ..... 3-12

## I

- Identification numbers ..... 9-1
- Ignition circuit cut-off system ..... 3-25
- Immobilizer system ..... 3-1
- Immobilizer system indicator light ..... 3-5
- Indicator lights and warning lights ..... 3-3
- Info switch ..... 3-13

## L

- License plate light bulb, replacing ..... 6-32
- Luggage strap holders ..... 3-24

## M

- Main switch/steering lock ..... 3-2
- Maintenance and lubrication, periodic ... 6-5

- Maintenance, emission control  
system .....6-3
- Malfunction indicator light (MIL) .....3-4
- Matte color, caution .....7-1
- Model label .....9-1
- Multi-function meter unit .....3-6

## N

- Neutral indicator light .....3-3

## O

- Oil pressure warning light .....3-3

## P

- Parking .....5-4
- Part locations .....2-1
- Pass switch .....3-12

## R

- Rear suspension, lubricating ..... 6-27

## S

- Safety information ..... 1-1
- Seat .....3-19
- Shifting .....5-3
- Shift pedal .....3-13
- Shock absorber assembly, adjusting ... 3-22
- Sidestand .....3-25
- Sidestand, checking and lubricating ... 6-27
- Spark plugs, checking ..... 6-9
- Specifications ..... 8-1
- Start/Engine stop switch .....3-12
- Starting the engine .....5-2
- Steering, checking ..... 6-29
- Storage .....7-3
- Storage compartment .....3-20
- Supporting the motorcycle ..... 6-33
- Swingarm pivots, lubricating .....6-28

## T

- Throttle grip and cable, checking and lubricating..... 6-25
- Throttle grip free play, checking..... 6-15
- Tires..... 6-16
- Tool kit..... 6-2
- Troubleshooting..... 6-33
- Troubleshooting chart ..... 6-35
- Turn signal indicator lights ..... 3-3
- Turn signal switch..... 3-12

## V

- Valve clearance ..... 6-16
- Vehicle identification number ..... 9-1
- Vehicle lights ..... 6-32

## W

- Wheel bearings, checking ..... 6-29
- Wheels..... 6-18
- Windshield ..... 3-20

## Y

- Yamalube..... 6-13









**MBK Industrie**

**Z.I. de Rouvroy 02100 Saint Quentin**

SAS au capital de 14 000 000 €

R.C St-Quentin B 329 035 422

PRINTED IN FRANCE  
2020.03 (E)